



Type 01



Articolo	N° Prof	Z	XX
11 108 0220100 XX	6	2	30-31,75-35-40-50
11 108 0220101 XX	1	2	30-31,75-35-40-50

CONFEZIONE PER ANTINE (TIPO 01)

Confezione di due elementi per la realizzazione di antine. A scelta, sono 6 le sagome disponibili per i profili delle antine e per ognuna di esse, variando la disposizione degli elementi, è possibile ottenerne 2 differenti configurazioni

KITCHEN CABINET SET (TYPE 01)

This kitchen cabinet set is composed of two elements. It is possible to choose a profile between 6 different ones available. Each of them enables to obtain two different configurations

FABRICACION DE PUERTA (TIPO 01)

Compuesto de 2 elementos para la realización de puertas. Sobre pedidos, tenemos, 6 molduras disponibles para tres perfiles de la puerta, una para cada uno, variando la disposición de los elementos, y posibilidad de obtener dos más

WERKZEUGGARNITUR FÜR MÖBELTOREN (TYP 01)

Die Garnitur besteht aus 2 Elementen mit 6 Ausführungsmöglichkeiten, durch die Kombination der Elemente ist es möglich eine zusätzliche Ausführung zu erhalten

PRIMA CONFIGURAZIONE

PROFILI

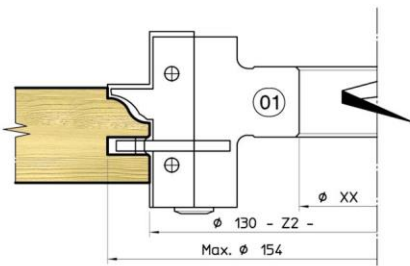

CONTRO PROFILO

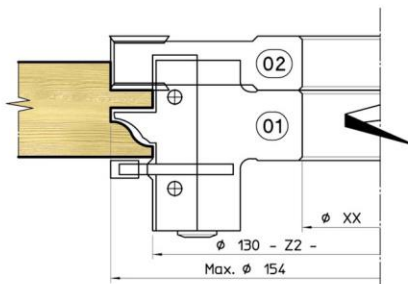

SAGOMA "A"

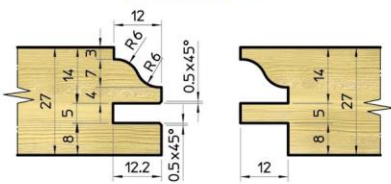

SAGOMA "B"

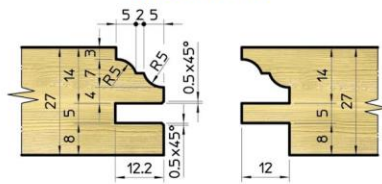

SAGOMA "C"

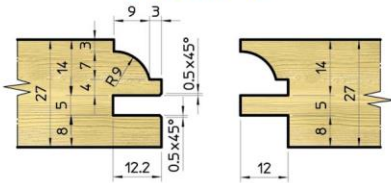

SAGOMA "D"

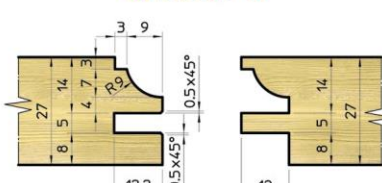

SAGOMA "E"

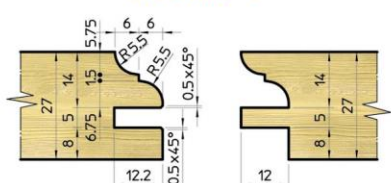

SAGOMA "F"

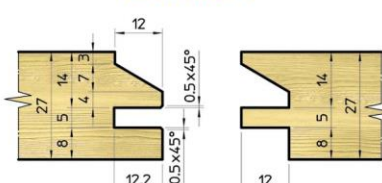

Ricambi / Spare parts		
Codice	Descrizione	Dimensione
RICAMBI ELEMENTO 01		
06 101 9822282	TAGLIENTE SAG. / PROF. KNIFE	50x2 mm
06 101 9822283	TAGLIENTE SAG. / PROF. KNIFE	50x2 mm
06 101 9822284	TAGLIENTE SAG. / PROF. KNIFE	50x2 mm
06 101 9822285	TAGLIENTE SAG. / PROF. KNIFE	50x2 mm
06 101 9822286	TAGLIENTE SAG. / PROF. KNIFE	50x2 mm
06 101 9822287	TAGLIENTE SAG. / PROF. KNIFE	50x2 mm
10 120 3001050	TASSELLO / WEDGE - UNIFIX	48 mm
08 101 0514616	VITE TASSELLO / SCREW WEDGE	M6x16 mm
06 118 7713360	SETTORE DENTATO / GROOVING INSERT	5,0 mm
08 101 0502508	VITE INCISORE / SCREW SPUR	M5x8 mm
RICAMBI ELEMENTO 02		
06 100 4510002	TAGLIENTE / KNIFE - EUROSISTEM	15x12x1,5 (45°)
10 120 3001015	TASSELLO / WEDGE - UNIFIX	13 mm
08 101 0514616	VITE TASSELLO / SCREW WEDGE	M6x16 mm
06 100 7710201	INCISORE / SPUR	14x14x2 mm
08 101 0604560	VITE INCISORE / SCREW SPUR	M5x6 mm

SECONDA CONFIGURAZIONE

PROFILI

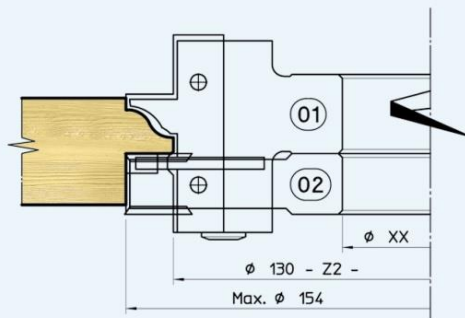

CONTRO PROFILO

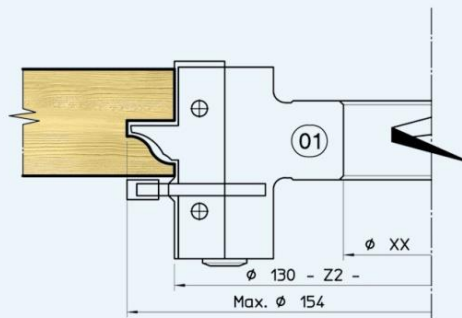

SAGOMA "A"

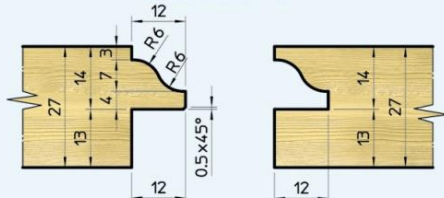

SAGOMA "B"

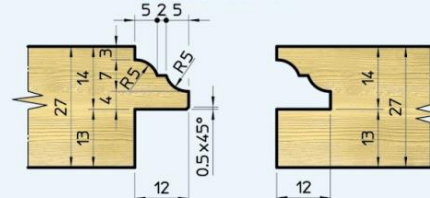

SAGOMA "C"

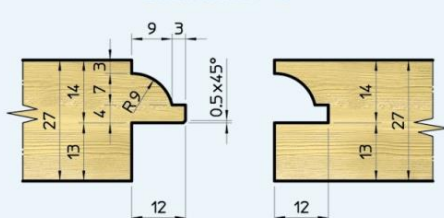

SAGOMA "D"

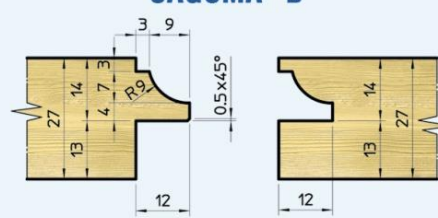

SAGOMA "E"

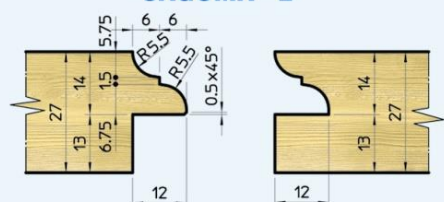

SAGOMA "F"

