

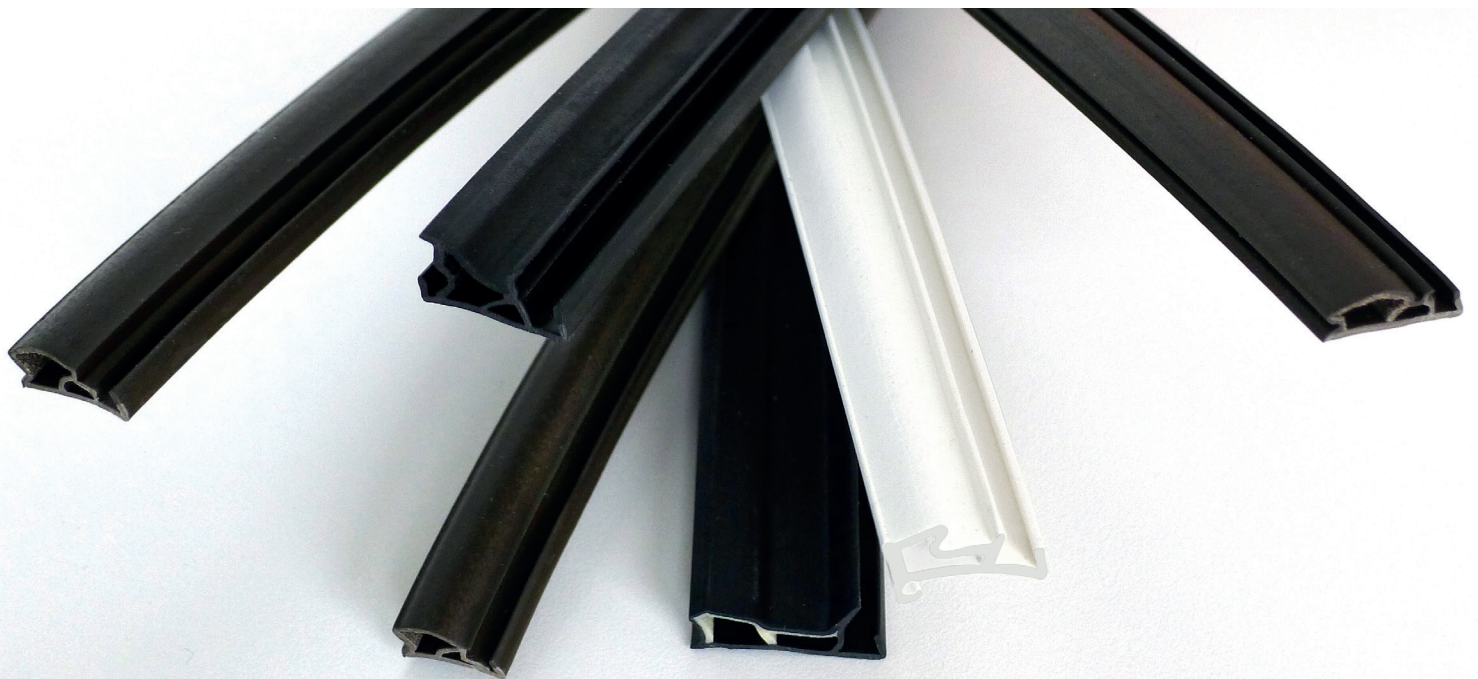

wooden frames solutions

OLTRE CIÒ CHE VEDI...
BEYOND WHAT YOU SEE...



GUARNIZIONI
GASKETS
JOINTS
JUNTAS DE GOMA

www.olimpiasistemi.com



INDICE

Introduzione.....2

Introduction / Introduction / Introducción

Guarnizioni Serie Azzurra.....4

Azzurra line / Série Azzurra / Serie Azzurra

Guarnizioni Serie 10.....8

"Serie 10" line / Série 10 / Serie 10

Guarnizioni Pellicolate.....14

*Gasket with removable film / Joint avec un film amovible /
Junta de goma con la película desprendible*

Guarnizioni Profili Vari.....16

*Various Gasket Profiles / Joints Profils différents /
Junta de goma perfiles varios*

Guarnizioni Alzanti.....21

*Gaskets-threshold sliding door system / Joints-euil pour portes coulissantes /
Juntas de goma-umbral para puertas correderas*

Guarnizioni Porte.....23

*Door Gaskets / Joints de ports /
Junta de goma puertas*

Accessori.....26

Accessories / Accessoires / Accessoires

Taglio Guarnizioni.....29

Gasket cut / Coupes de joints / Cortes de juntas de goma



10000230
pag.20



10000384
pag.20



10001057
pag.27



10001151
pag.27



11000140
pag.25



11000336
pag.23



11000360
pag.24



11000366
pag.23



11000374
pag.23



11000382
pag.24



11000510
pag.23



11000610
pag.19



11000611
pag.19



11000612
pag.19



11000613
pag.19



11000614
pag.20



11000616
pag.20



11000618
pag.20



11000738
pag.18



11000835
pag.24



11000842
pag.23



11000858
pag.24



15000306
pag.17



15000334
pag.16



15000368
pag.17



15000446
pag.10



15000450
pag.10



15000486
pag.12



15000512
pag.12



15000514
pag.12



15000522
pag.9



15000524
pag.9



15000526
pag.10



15000528
pag.9



15000530
pag.9



15000678
pag.11



15000734
pag.24



15000736
pag.18



15000742
pag.11



15000758
pag.18



15000778
pag.16



15000798
pag.5



15000800
pag.5



15000802
pag.5



15000804
pag.7



15000808
pag.6



15000814
pag.12



15000816
pag.5



15000818
pag.22



15000850
pag.7



15000854
pag.6



15000874
pag.15



15000876
pag.15



15000878
pag.15



15000882
pag.15



15000884
pag.6



15000908
pag.12



15000910
pag.6



15000912
pag.5



15000920
pag.7



15000930
pag.16



15000932
pag.18



15000935
pag.21



15000938
pag.18



15000940
pag.21



15000948
pag.7

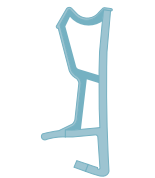

15000950
pag.6



15000972
pag.17



15000976
pag.7



15000980
pag.17
pag.19



15000990
pag.9



15001004
pag.10



15008020
pag.10



16000902
pag.22



41800468
pag.27



41801001
pag.27



41801002
pag.27



43905931
pag.26

GUARNIZIONI

Una gamma completa per tutte le esigenze che si perfeziona nell'ultima generazione: la Serie Azzurra, un nuovo materiale che unisce una grande resistenza ad una elevata dinamicità e alle più alte performance di isolamento termico e acustico.

GASKETS

The complete gaskets range respond to all customers demands and find his top solution in the last generation product: the Serie Azzurra, a new material with high resistance to dynamic stress with the best performance in terms of thermal and acoustic insulation.

JOINTS

Une gamme complète pour toutes les exigences qui trouve sa perfection sur la nouvelle génération: la Série Azzurra, un nouveau matériau qui combine une grande résistance à la fatigue dynamique et la plus haute performance d'isolation thermique et acoustique.

JUNTAS DE GOMA

La gama completa de juntas responde a todos las demandas de los clientes y encontra su solución superior en el última generación de producto: la Serie Azzurra, un nuevo material con alta resistencia a la tensión dinámica con el mejor rendimiento térmico y de aislamiento acústico.

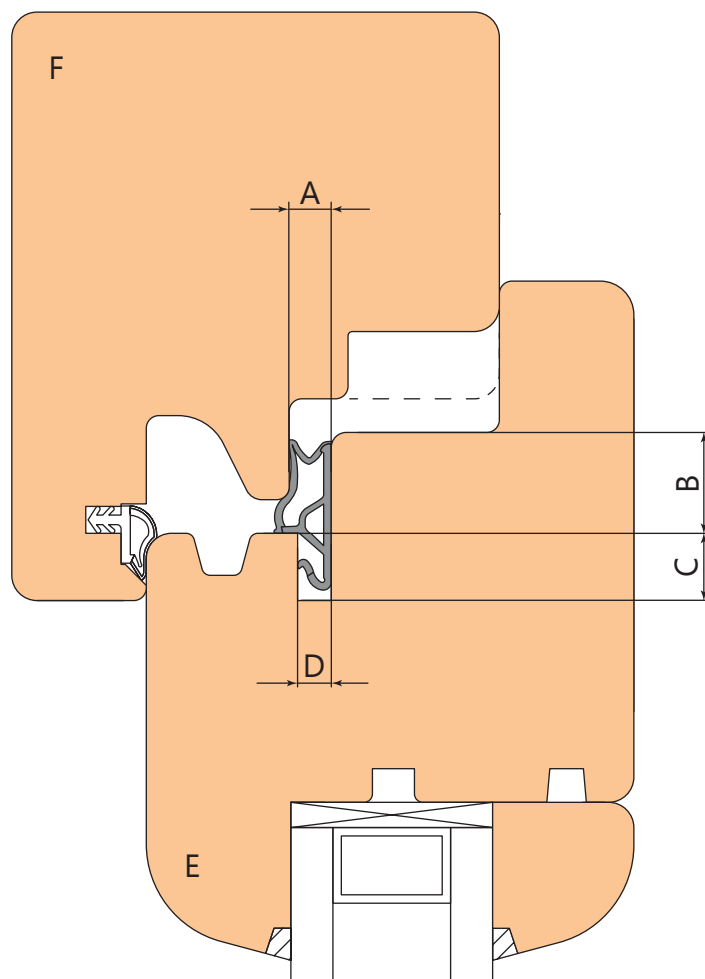

DIDASCALIA

LEGEND / LÉGENDE / SUBTÍTULO

- A** **Aria**
Air / Air / Aire
- B** **Battuta**
Beat / Appui / Vencer
- C** **Profondità fresatura**
Depth housing / Profondeur rainure / Profundidad Enclavamiento
- D** **Larghezza fresatura**
Width milled / Largeur usinage / Ancho molida
- F** **Telaio**
Frame / Dormant / Marco
- E** **Anta**
Sash / Ouvrant / Hoja

TPE espanso con cellule chiuse

TPE foam with closed cell
Mousse de TPE avec cellules fermées
Espuma de TPE con células cerradas

Nuovo aggancio semirigido e morbido

New hooking soft and hard
Nouvelle queue de sapin souple et dur.
Nuevo enganche semirrigido y blando

Sede alloggiamento pinnetta

Pinnetta housing
Logement de la lamelle de fermeture (pinnetta)
Alojamiento de pineta

Materiale compatto

Compact material
Matière compacte
Material compacto

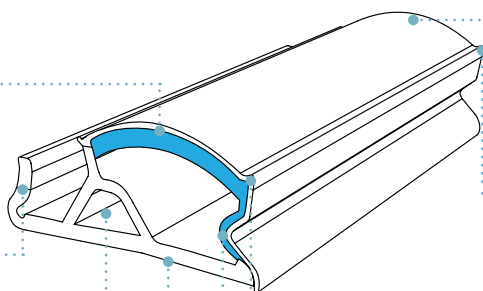

Pellicola Protettiva

Protective film
Film de protection
Película di protection

Aletta chiusura

Closing flap
Ailette de fermeture
Pineta de cierre

Cerniere

Hinges
Charnières
Bisagras

Effetto molla

Spring effect
Effet de ressort
Efecto resorte

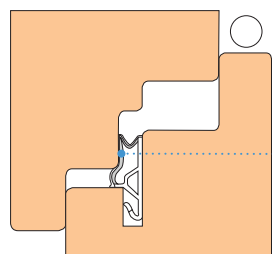

Adattamento al legno

Adaptation to wood
Adaptation au bois
Adaptación a la madera

IT

La nuova e innovativa serie Azzurra in TPE espanso a cellule chiuse è stata studiata per garantire le massime performance di isolamento, resistenza dinamica, facilità di montaggio.

EN

The new and innovative "Azzurra" line in TPE closed cells foam, has been designed to ensure maximum performance for insulation, resistance to dynamic stress, easy assembling.

FR

La nouvelle et innovante série Azzurra en TPE expansé à cellules fermées a été conçue afin de garantir des performances optimales en termes de calfeutrement, résistance à la fatigue dynamique, facilité de montage.

ES

La nueva e innovadora serie Azzurra en TPE en espuma de celdas cerradas se ha estudiado para garantizar el mejor rendimiento en estanqueidad, resistencia mecánica, facilidad de montaje.

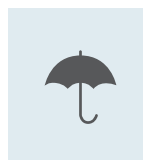

Massima protezione all'acqua

Maximum water protection
Maximale protection a l'eau
Máxima estanqueidad al agua



Elevato isolamento termico

High thermal insulation
Haute isolation thermique
Elevado aislamiento térmico



Riciclabile

Recyclable
Recyclable
Reciclable

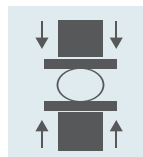

Alta resistenza meccanica

High mechanical strength
Haute résistance mécanique
Elevada resistencia mecánica



Elevato isolamento acustico

High sound insulation
Haute isolation sonore
Elevado aislamiento acústico

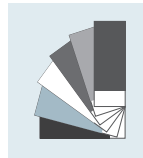









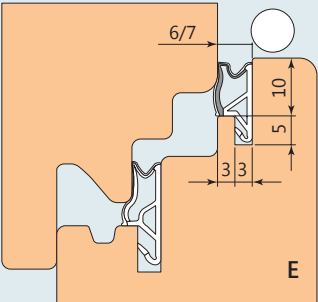



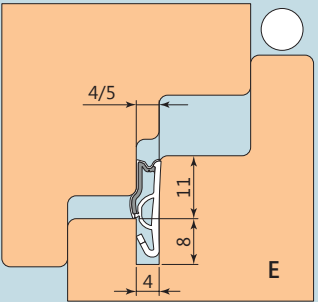



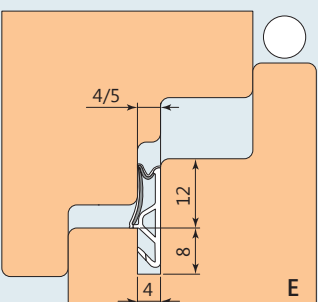



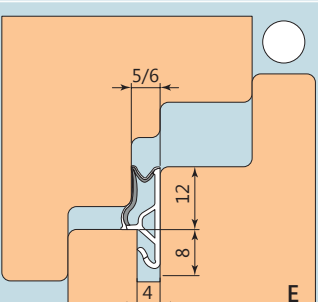



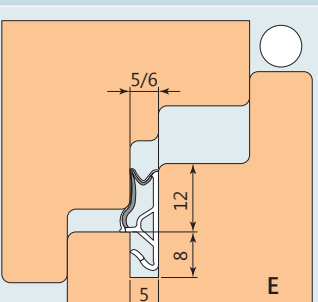

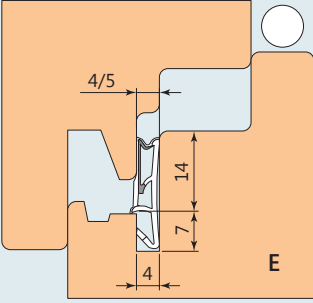

Gamma completa di colori

Complete range of colours
Gamme complète de couleurs
Completa gama de colores

Guarnizioni per Anta "E"

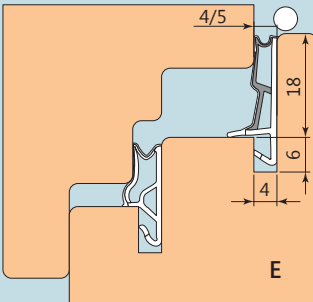









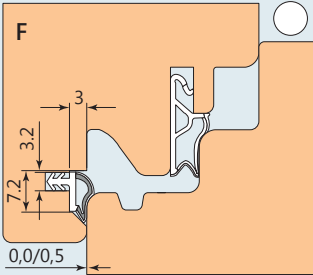

For Sash / Pour Ouvrant / Para la Hoja

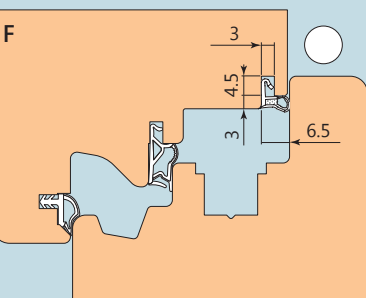



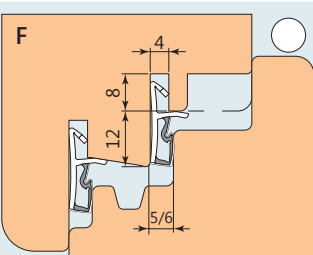





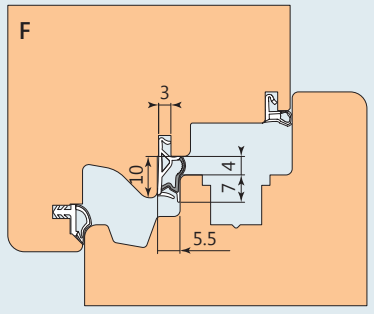



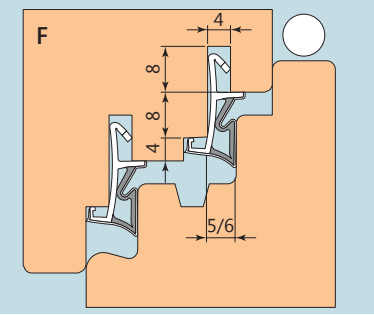



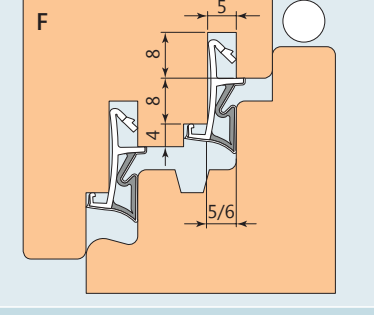

	Colore Colour	Codice Code	Quantità per imballo Packaging quantity	Quantità per pallet Pallet quantity
 <p>TPE.3-S</p>		15000800.11	250 m	5.000 m
		15000800.12	250 m	5.000 m
		15000800.13	250 m	5.000 m
	 PINNETTA	41801001/41801002		
 <p>TPE.3-S</p>		15000912.11	200 m	4.000 m
		15000912.12	200 m	4.000 m
		15000912.13	200 m	4.000 m
	 PINNETTA	41801001/41801002		
 <p>TPE.3-S</p>		15000802.11	200 m	4.000 m
		15000802.12	200 m	4.000 m
		15000802.13	200 m	4.000 m
	 PINNETTA	41801001/41801002		
 <p>TPE.3-S</p>		15000798.11	200 m	4.000 m
		15000798.12	200 m	4.000 m
		15000798.13	200 m	4.000 m
	 PINNETTA	41801001/41801002		
 <p>TPE.3-S</p>		15000816.11	170 m	3.400 m
		15000816.12	170 m	3.400 m
		15000816.13	170 m	3.400 m
	 PINNETTA	41801001/41801002		

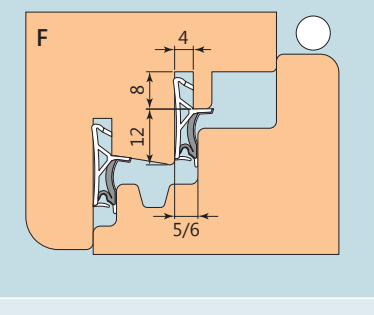
	Colore Colour	Codice Code	Quantità per imballo Packaging quantity	Quantità per pallet Pallet quantity
 <p>TPE.3-S</p>		15000854.11	200 m	4.000 m
		15000854.12	200 m	4.000 m
		15000854.13	200 m	4.000 m
	 PINNETTA	41800468		
 <p>TPE.3-S</p>		15000950.11	150 m	3.000 m
		15000950.12	150 m	3.000 m
		15000950.13	150 m	3.000 m

Guarnizioni per Telaio "F"

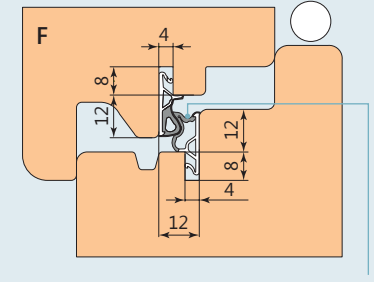
For Frame / Pour Dormant / Para Marco

 <p>TPE.3-S</p>		15000808.11	400 m	8.000 m
		15000808.12	400 m	8.000 m
		15000808.13	400 m	8.000 m
 <p>TPE.3-S</p>		15000910.11	300 m	6.000 m
		15000910.12	300 m	6.000 m
		15000910.13	300 m	6.000 m
 <p>TPE.3-S</p>		15000884.11	150 m	3.000 m
		15000884.12	150 m	3.000 m
		15000884.13	150 m	3.000 m

	Colore Colour	Codice Code	Quantità per imballo Packaging quantity	Quantità per pallet Pallet quantity
 <p>TPE.3-S</p>		15000976.11	200 m	4.000 m
		15000976.12	200 m	4.000 m
		15000976.13	200 m	4.000 m
	 PINNETTA	41801001/41801002		
 <p>TPE.3-S</p>		15000920.11	130 m	2.600 m
		15000920.12	130 m	2.600 m
		15000920.13	130 m	2.600 m
				
 <p>TPE.3-S</p>		15000850.11	130 m	2.600 m
		15000850.12	130 m	2.600 m
		15000850.13	130 m	2.600 m
				
 <p>TPE.3-S</p>		15000948.11	150 m	3.000 m
		15000948.12	150 m	3.000 m
		15000948.13	150 m	3.000 m
	 PINNETTA	41801001/41801002		
 <p>TPE.3-S</p> <p>in combinazione con: 15000798</p>		15000804.11	200 m	4.000 m
		15000804.12	200 m	4.000 m
		15000804.13	200 m	4.000 m
				

TPE monodensità

Monodensity
Monodensité
Monodensidad

Materiale morbido

Soft material
Matériau souple
Material suave

Sede alloggiamento pinnetta

Housing pinnetta
Logement de la lamelle de fermeture
Alojamiento aleta

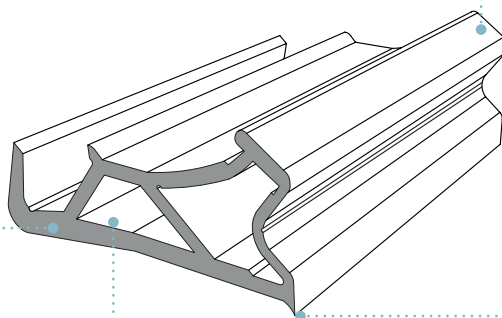

Aletta chiusura

Closing flap
Ailette de fermeture
Pineta de cierre

Profilo aderenza

Grip profilo
Profilo aderençe
Grip perfil

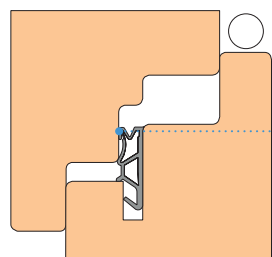

Adattamento al legno

Adaptation to wood
Adaptation au bois
Adaptación a la madera

IT

La geometria e la morbidezza del termoplastico delle guarnizioni serie "10" permettono un'efficace chiusura dell'aria fra anta e telaio e mantengono un ottimo ritorno elastico della stessa.

EN

The geometry and the softness of the thermoplastic seals series "10", gives a soft closing between sash and frame maintaining an excellent elastic return, and the best insulation.

FR

La géométrie et la douceur de la série des joints thermoplastique "10" permettent fermeture efficace de l'air entre le vantail et de maintenir un excellent retour élastique de celui-ci.

ES

La geometría y la suavidad de la serie de sellos termoplástico "10" permiten cierre eficiente del aire entre la hoja y el marco y mantienen un excelente retorno elástico del mismo.

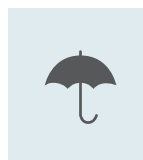

Massima protezione all'acqua

Maximum water protection
Maximale protection a l'eau
Máxima estanqueidad al agua



Elevato isolamento termico

High thermal insulation
Haute isolation thermique
Aislamiento térmico de alta



Riciclabile

Recyclable
Recyclable
Reciclable

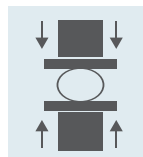

Alta resistenza meccanica

High mechanical strength
Haute résistancemécanique
Elevada resistencia mecánica



Elevato isolamento acustico

High sound insulation
Haute isolation sonore
Elevado aislamiento acústico

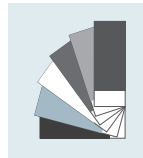









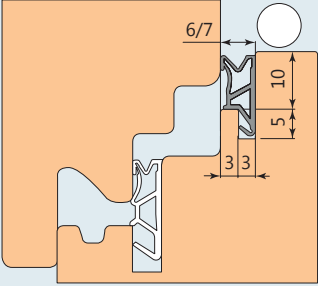



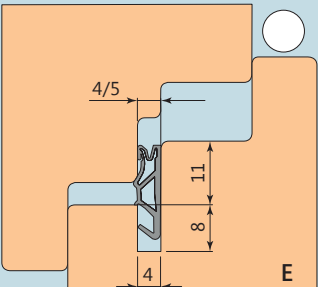



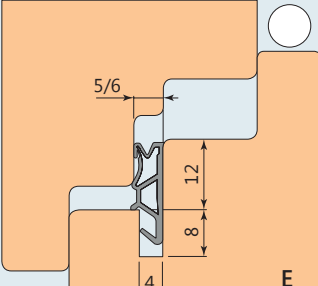



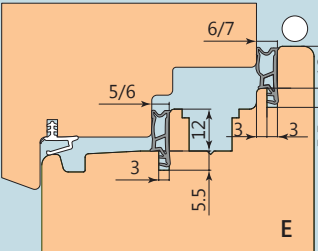



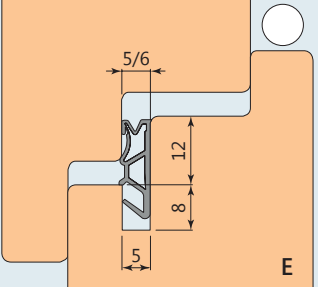





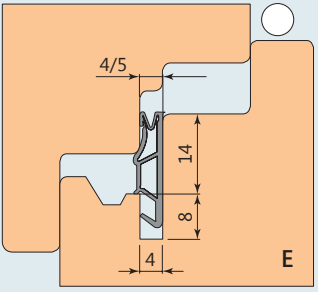



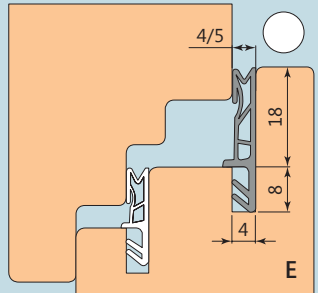

Gamma completa di colori

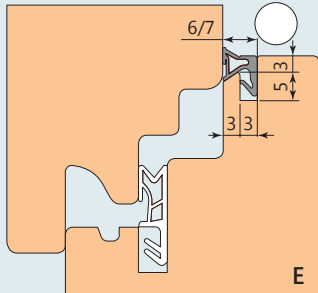
Complete range of colours
Gamme complète de couleurs
Completa gama de colores

Guarnizioni per Anta "E"

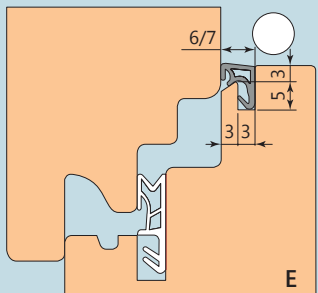



For Sash / Pour Ouvrant / Para la Hoja

	Colore Colour	Codice Code	Quantità per imballo Packaging quantity	Quantità per pallet Pallet quantity
 <p>TPE.1</p>		15000526.11	230 m	4.600 m
		15000526.12	230 m	4.600 m
		15000526.13	230 m	4.600 m
	 PINNETTA 41800468			
 <p>TPE.1</p>		15000522.11	240 m	4.800 m
		15000522.12	240 m	4.800 m
		15000522.13	240 m	4.800 m
	 PINNETTA 41800468			
 <p>TPE.1</p>		15000528.11	200 m	4.000 m
		15000528.12	200 m	4.000 m
		15000528.13	200 m	4.000 m
	 PINNETTA 41800468			
 <p>TPE.1</p>		15000990.11	200 m	4.000 m
		15000990.12	200 m	4.000 m
		15000990.13	200 m	4.000 m
	 PINNETTA 41800468			
 <p>TPE.1</p>		15000530.11	200 m	4.000 m
		15000530.12	200 m	4.000 m
		15000530.13	200 m	4.000 m
	 PINNETTA 41800468			

	Colore Colour	Codice Code	Quantità per imballo Packaging quantity	Quantità per pallet Pallet quantity
 <p>TPE.1</p>		15000524.11	200 m	4.000 m
		15000524.12	200 m	4.000 m
		15000524.13	200 m	4.000 m
	 PINNETTA 41800468			
 <p>TPE.1</p>		15008020.11	180 m	3.600 m
		15008020.12	180 m	3.600 m
		15008020.13	180 m	3.600 m
 <p>TPE.1</p>		15000446.11	400 m	8.000 m
		15000446.12	400 m	8.000 m
		15000446.13	400 m	8.000 m
 <p>TPE.1</p>		15000450.11	400 m	8.000 m
		15000450.12	400 m	8.000 m
		15000450.13	400 m	8.000 m

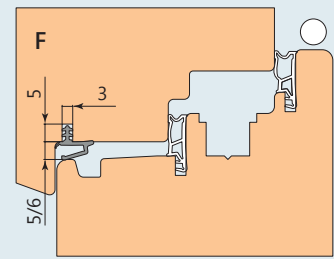
Guarnizioni per Telaio "F"

For Frame / Pour Dormant / Para Marco



 <p>TPE.1</p>		15001004.11	300 m	6.000 m
		15001004.12	300 m	6.000 m
		15001004.13	300 m	6.000 m

Guarnizioni per Telaio "F"

For Frame / Pour Dormant / Para Marco

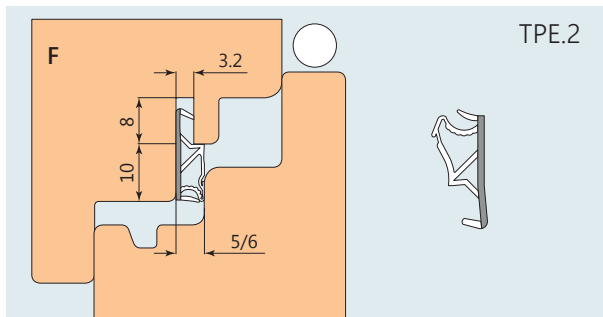

Colore Colour	Codice Code	Quantità per imballo Packaging quantity	Quantità per pallet Pallet quantity
------------------	----------------	--	--

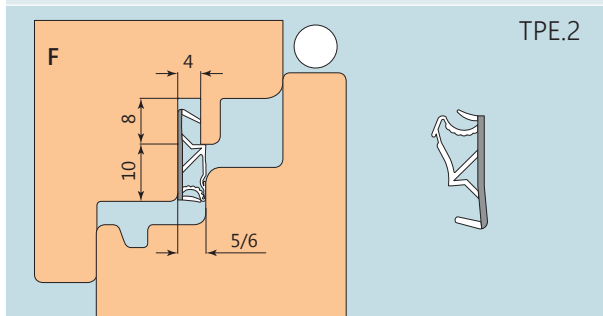

	15000678.11	220 m	4.400 m
	15000678.12	220 m	4.400 m
	15000678.13	220 m	4.400 m

 PINNETTA **41801001/41801002**











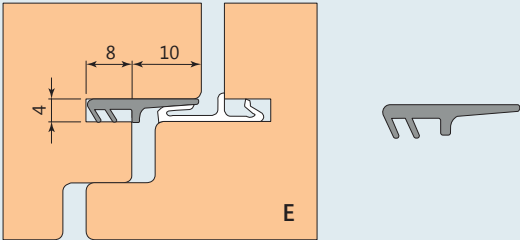



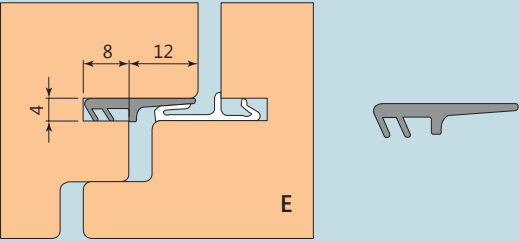



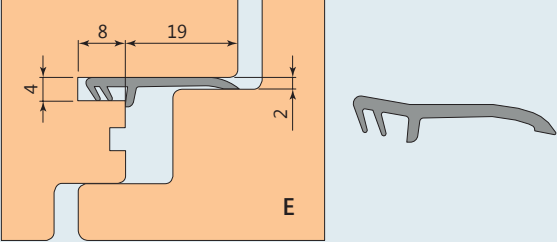

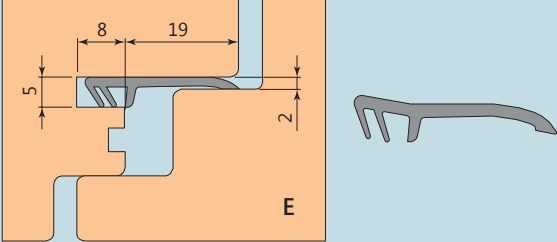

	15000742.11	220 m	4.400 m
	15000742.12	220 m	4.400 m
	15000742.13	220 m	4.400 m

 PINNETTA **41801001/41801002**

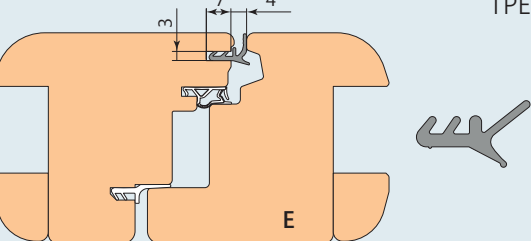
Guarnizioni per Montante Centrale

Mast for Central / Mât de Central
Mástil para Central

	Colore Colour	Codice Code	Quantità per imballo Packaging quantity	Quantità per pallet Pallet quantity
 <p>TPE.1</p>		15000908.11	260 m	5.200 m
		15000908.12	260 m	5.200 m
		15000908.13	260 m	5.200 m
 <p>TPE.1</p>		15000486.11	260 m	5.200 m
		15000486.12	260 m	5.200 m
		15000486.13	260 m	5.200 m
 <p>TPE.1</p>		15000512.11	200 m	4.000 m
		15000512.12	200 m	4.000 m
		15000512.13	200 m	4.000 m
 <p>TPE.1</p>		15000514.11	200 m	4.000 m
		15000514.12	200 m	4.000 m
		15000514.13	200 m	4.000 m
 <p>TPE.1</p>		15000814.11	100 m	4.000 m
		15000814.12	100 m	4.000 m
		15000814.13	100 m	4.000 m

Montaggio Guarnizione 15000486 / 15000908

Mounting Gasket / Joint de montage / Junta de montaje

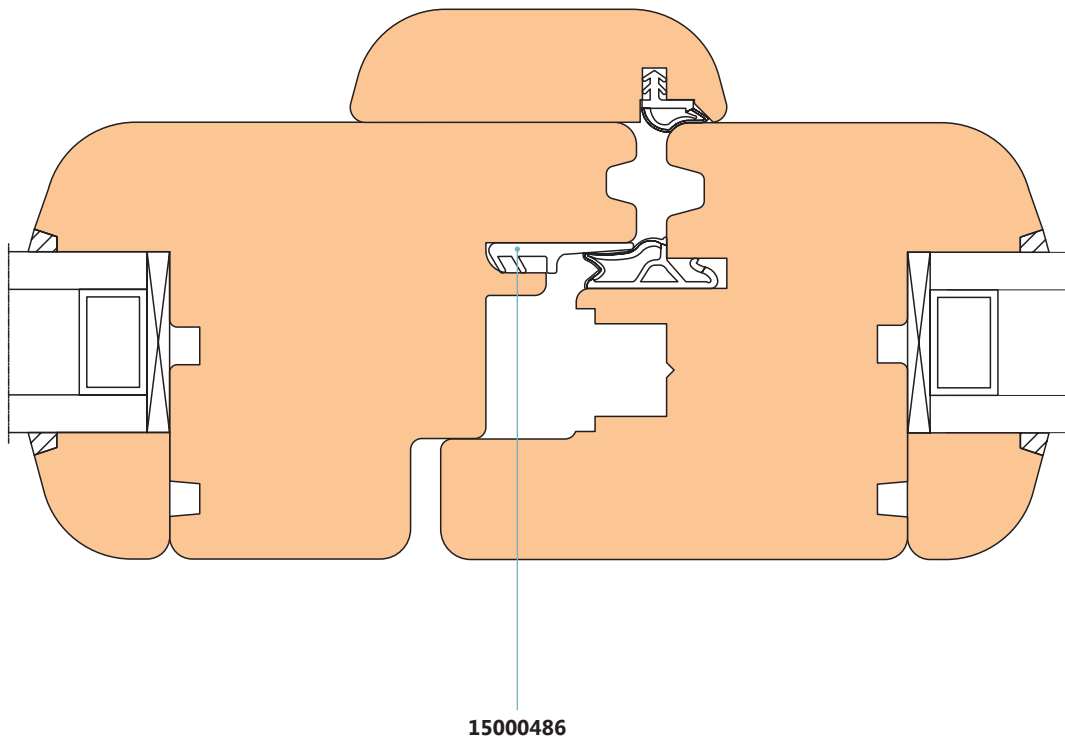

FASE 1

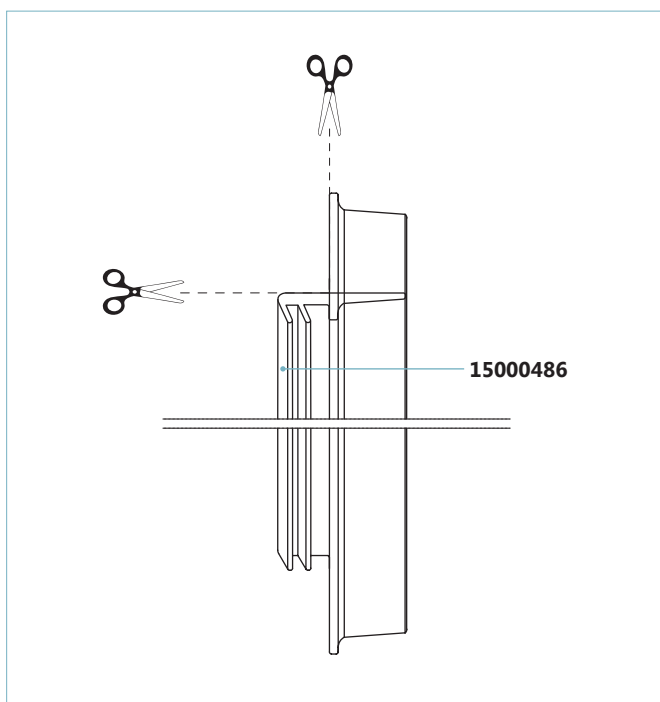

FASE 2

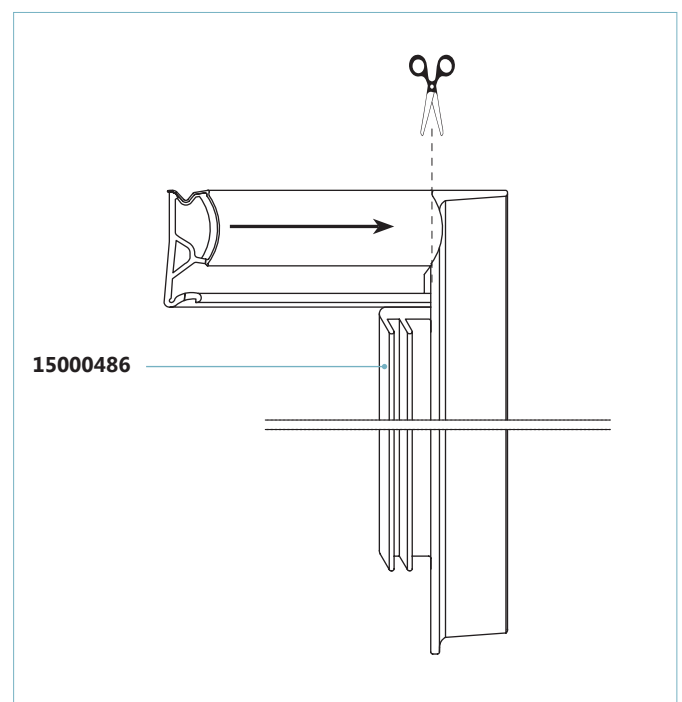

TPE a doppia densità compatto e morbido

Double density hard and soft
Double densité compact et dur
Doble densidad duro y blando

Nuovo aggancio semirigido e morbido

New hooking soft and hard
Nouvelle queue de sapin souple et dur.
Nuevo enganche semirrigido y blando

Sede alloggiamento pinnetta

Pinnetta housing
Logement de la lamelle de fermeture (pinnetta)
Alojamiento de pineta

Materiale compatto

Compact material
Matière compacte
Material compacto

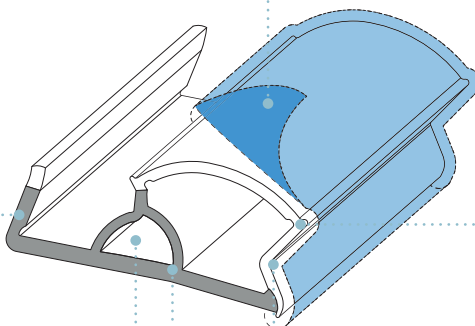

Pellicola di protezione

Protective film
Film de protection
Pélicula di proteccion

Cerniere

Hinges
Charnières
Bisagras

Effetto molla

Spring effect
Effet de ressort
Efecto resorte

IT

Nuova serie di guarnizioni con pellicola asportabile per garantire la protezione durante la verniciatura a base d'acqua e solventi. Il corpo della guarnizione è in TPE coestruso in due densità. Il gambo rigido permette l'inserimento facile e rapido, la parte morbida garantisce la massima aderenza al legno per una chiusura soft con il miglior isolamento termico.

EN

New gasket line with removable film to be protected during painting with water-based and synthetic paints. The gasket material is in TPE coextruded in two parts with different density. The shank is hard for quick and easy assembling and the body is soft so to have adhesion to the wood for soft closing and the best insulation.

FR

Nouvelle ligne de joint avec un film amovible pour permettre la protection pendant la peintures à base d'eau et certains solvants. Le matériau de joint est co-extrudé en TPE a double densités. Le sapin dur pour une insertion rapide et facile et le corps souple, afin d'adhérer sur le bois pour une fermeture en douceur et la meilleure isolation.

ES

Nueva línea de junta con la película desprendible para proteger de las pinturas a base de agua y solventes. El material de la junta se coextruye en TPE en dos densidades. El vástago es difícil para el montaje fácil y rápido y el cuerpo es blando, de manera de tener la mejor adherencia a la madera para el cierre suave y un mejor aislamiento.

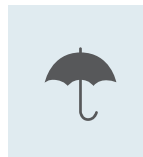

Massima protezione all'acqua

Maximum water protection
Maximale protection a l'eau
Máxima estanqueidad al agua



Elevato isolamento termico

High thermal insulation
Haute isolation thermique
Elevado aislamiento térmico



Riciclabile

Recyclable
Recyclable
Reciclable

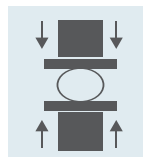

Alta resistenza meccanica

High mechanical strength
Haute résistance mécanique
Elevada resistencia mecánica



Elevato isolamento acustico

High sound insulation
Haute isolation sonore
Elevado aislamiento acústico



Compatibilità con vernici all'acqua

Compatible with water-based paints
Compatibilité avec peintures à base d'eau
Compatibilidad con pinturas a base de agua

GUARNIZIONI PELLICOLATE IN TPE.2

Guarnizioni per Anta "E"

For Sash / Pour Ouvrant / Para la Hoja

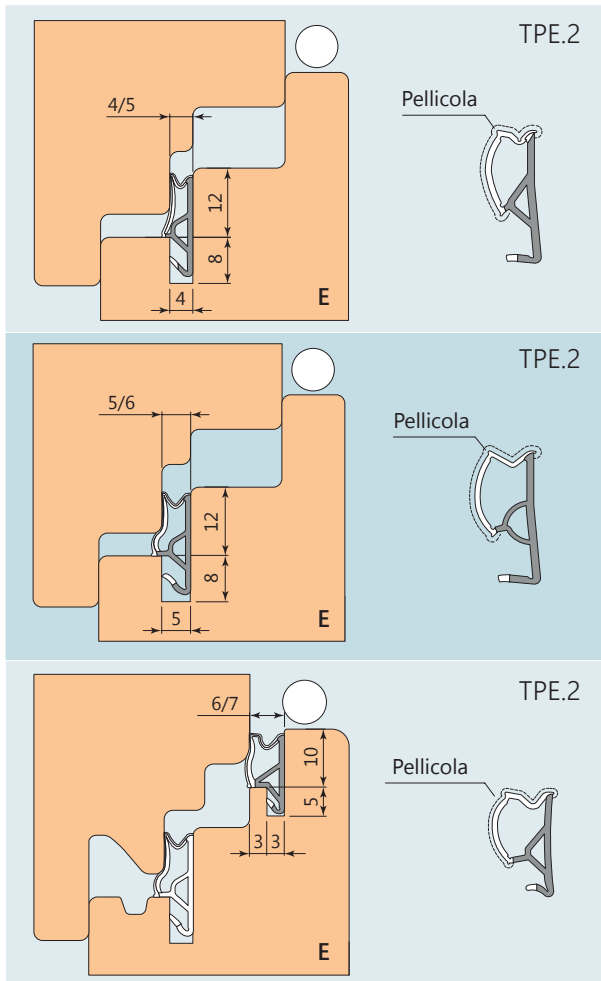

Colore
Colour

Codice
Code

Quantità per imballo
Packaging quantity

Quantità per pallet
Pallet quantity



15000882.11

200 m

4.000 m



15000882.12

200 m

4.000 m



15000882.13

200 m

4.000 m



PINNETTA 41801001/41801002



15000874.11

170 m

3.400 m



15000874.12

170 m

3.400 m



15000874.13

170 m

3.400 m



PINNETTA 41801001/41801002



15000876.11

250 m

5.000 m



15000876.12

250 m

5.000 m



15000876.13

250 m

5.000 m



PINNETTA 41801001/41801002

Guarnizioni per Telaio "F"

For Frame / Pour Dormant / Para Marco

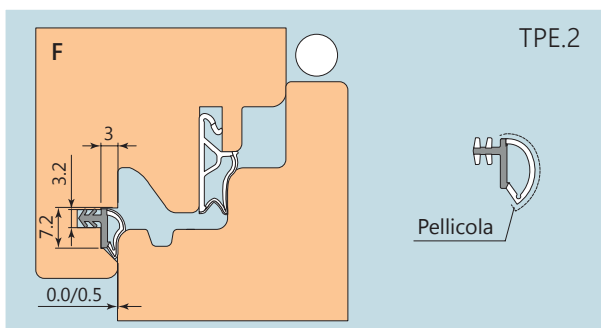

15000878.11

400 m

8.000 m



15000878.12

400 m

8.000 m



15000878.13

400 m

8.000 m

Guarnizioni per Vetro

For Glass / Pour Le Verre / Para El Vidrio

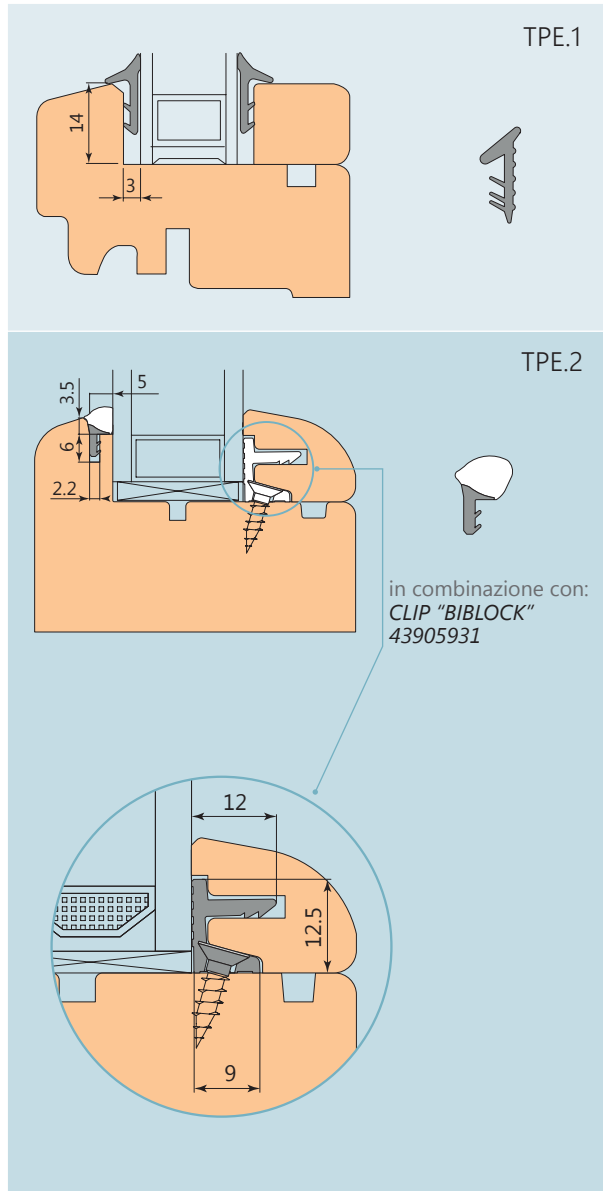

Colore
Colour

Codice
Code

Quantità per imballo
Packaging quantity

Quantità per pallet
Pallet quantity



15000334.11

200 m

4.000 m



15000334.12

200 m

4.000 m



15000334.13

200 m

4.000 m



15000930.11

400 m

8.000 m



15000930.12

400 m

8.000 m



15000930.13

400 m

8.000 m



15000930.50

400 m

8.000 m

Cava Ferramenta

Hardware / Quincaillerie / Herramienta

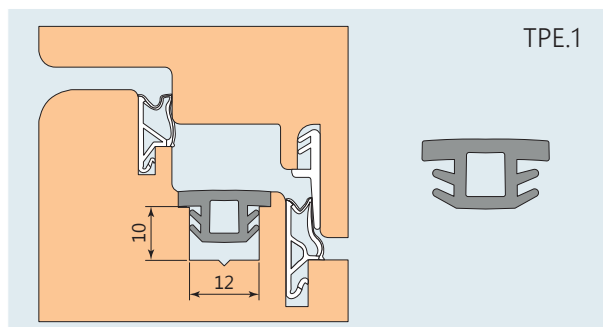

Colore
Colour

Codice
Code

Quantità per imballo
Packaging quantity

Quantità per pallet
Pallet quantity



15000778.26

264 m

4.224 m











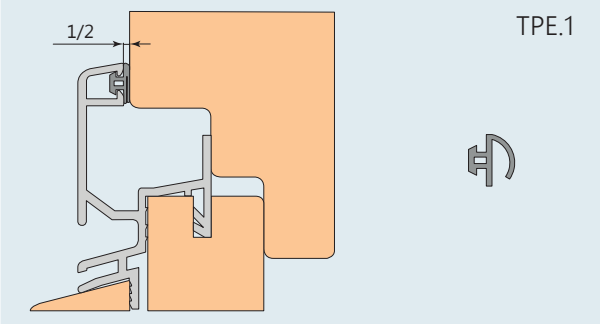

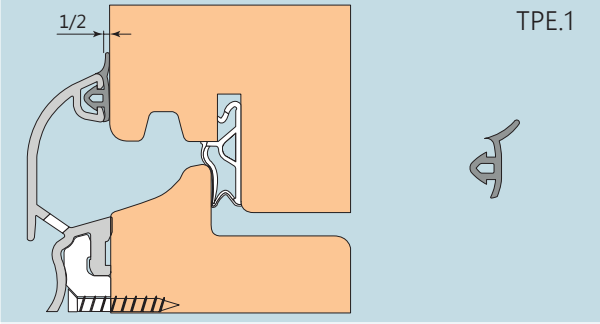

GUARNIZIONI PROFILI VARI

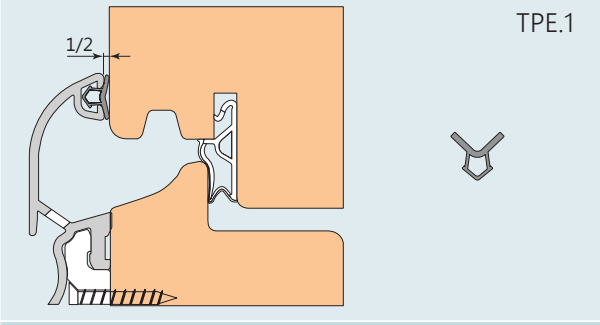
VARIOUS GASKETS / DIVERS JOINTS / VARIAS JUNTAS



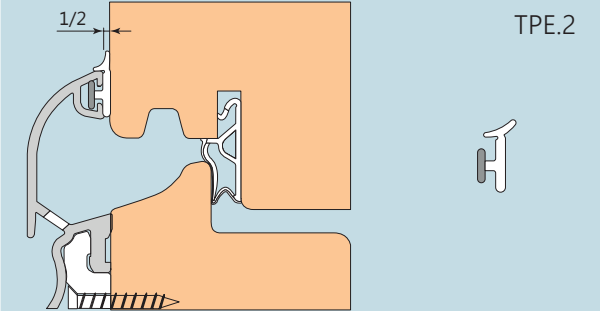









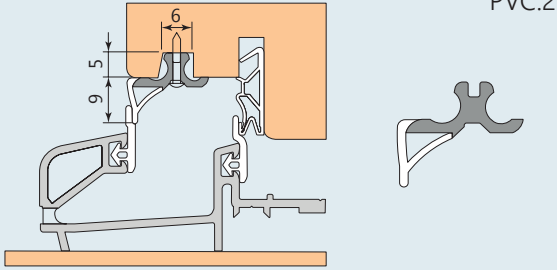



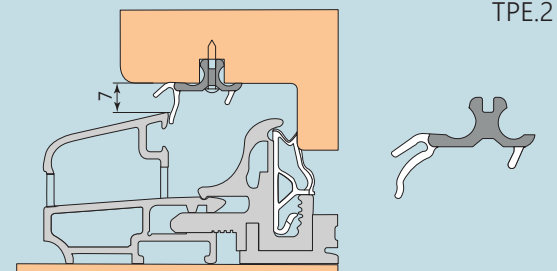



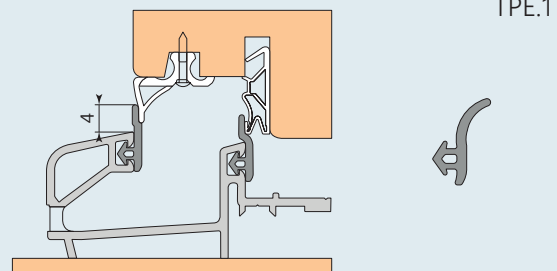

Per Gocciolatoi

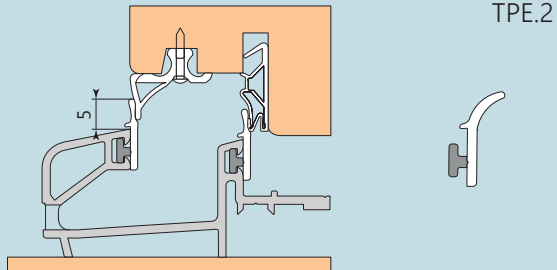
For Drip Mouldings / Pour Rejets D'eau / Para Goterones Vierteaguas

	Colore Colour	Codice Code	Quantità per imballo Packaging quantity	Quantità per pallet Pallet quantity
		15000306.11	250 m	7.500 m
		15000306.12	250 m	7.500 m
		15000306.13	250 m	7.500 m
		15000980.11	350 m	7.000 m
		15000980.12	350 m	7.000 m
		15000980.13	350 m	7.000 m
		15000368.11	250 m	7.500 m
		15000368.12	250 m	7.500 m
		15000368.13	250 m	7.500 m
		15000972.11	200 m	2.000 m
		15000972.12	200 m	2.000 m
		15000972.13	200 m	2.000 m

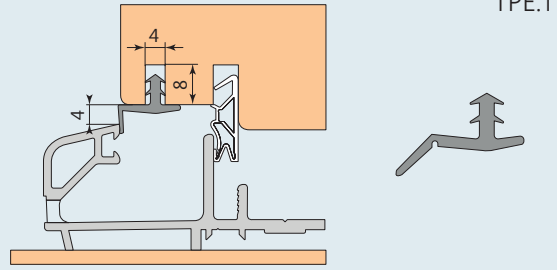
Guarnizioni per Soglie











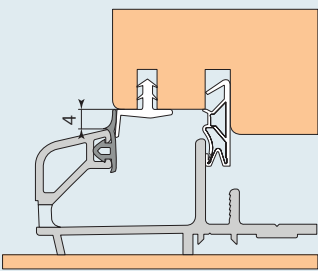

For Thresholds / Pour Seuils / Para Umbrales

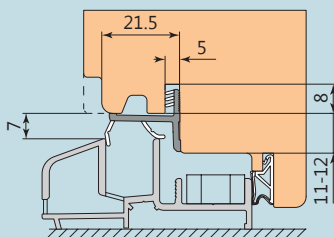
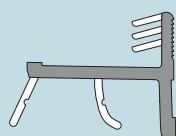

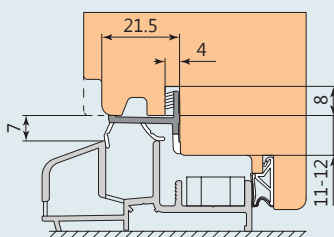
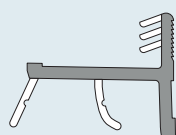

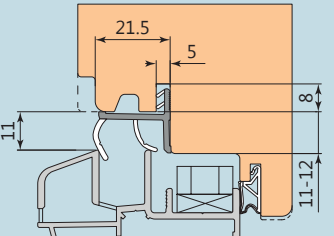
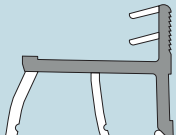

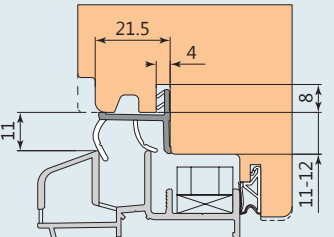
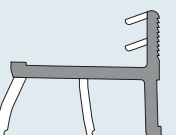

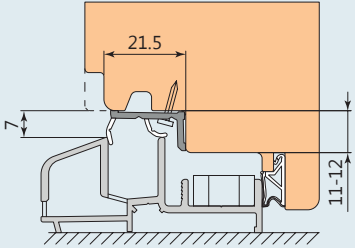

	Colore Colour	Codice Code	Quantità per imballo Packaging quantity	Quantità per pallet Pallet quantity
 <p>PVC.2</p>		11000738.11	150 m	3.000 m
		11000738.12	150 m	3.000 m
		11000738.13	150 m	3.000 m
 <p>TPE.2</p>		15000938.11	150 m	3.000 m
		15000938.12	150 m	3.000 m
		15000938.13	150 m	3.000 m
 <p>TPE.1</p>		15000736.11	300 m	6.000 m
		15000736.12	300 m	6.000 m
		15000736.13	300 m	6.000 m
 <p>TPE.2</p>		15000932.11	300 m	6.000 m
		15000932.12	300 m	6.000 m
		15000932.13	300 m	6.000 m
 <p>TPE.1</p>		15000758.11	180 m	3.600 m
		15000758.12	180 m	3.600 m
		15000758.13	180 m	3.600 m

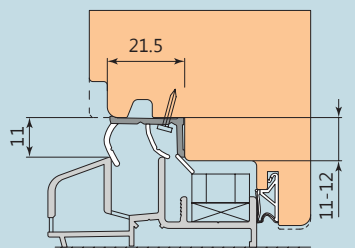
GUARNIZIONI PROFILI VARI

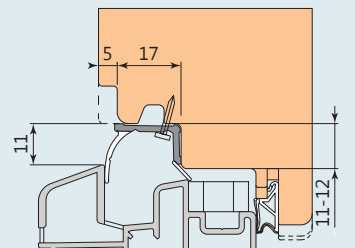
VARIOUS GASKETS / DIVERS JOINTS / VARIAS JUNTAS

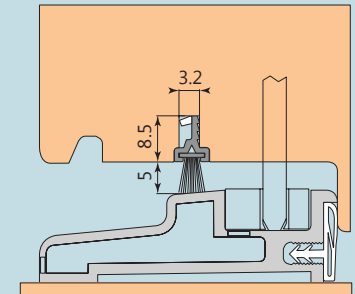

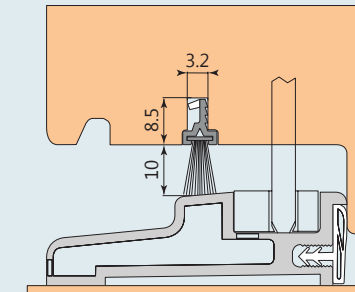
	Colore Colour	Codice Code	Quantità per imballo Packaging quantity	Quantità per pallet Pallet quantity
 <p>TPE.1</p> 		15000980.11	350 m	7.000 m
		15000980.12	350 m	7.000 m
		15000980.13	350 m	7.000 m
 <p>PVC.2</p> 		11000610.12	150 m	3.000 m
 <p>PVC.2</p> 		11000611.12	150 m	3.000 m
 <p>PVC.2</p> 		11000612.12	150 m	3.000 m
 <p>PVC.2</p> 		11000613.12	150 m	3.000 m

	Colore Colour	Codice Code	Quantità per imballo Packaging quantity	Quantità per pallet Pallet quantity
 <p>PVC.2</p>		11000614.12	150 m	3.000 m
 <p>PVC.2</p>		11000616.12	150 m	3.000 m
 <p>PVC.2</p>		11000618.12	150 m	3.000 m
 <p>PVC.2</p>		10000384.12	215 m	2.580 m
 <p>PVC.2</p>		10000230.12	215 m	2.580 m

GUARNIZIONI ALZANTE SCORREVOLE

GASKETS-THRESHOLD SLIDING DOOR SYSTEM / JOINTS-SEUIL POUR PORTES COULISSANTES / JUNTAS DE GOMA-UMBRAL PARA PUERTAS CORREDERAS

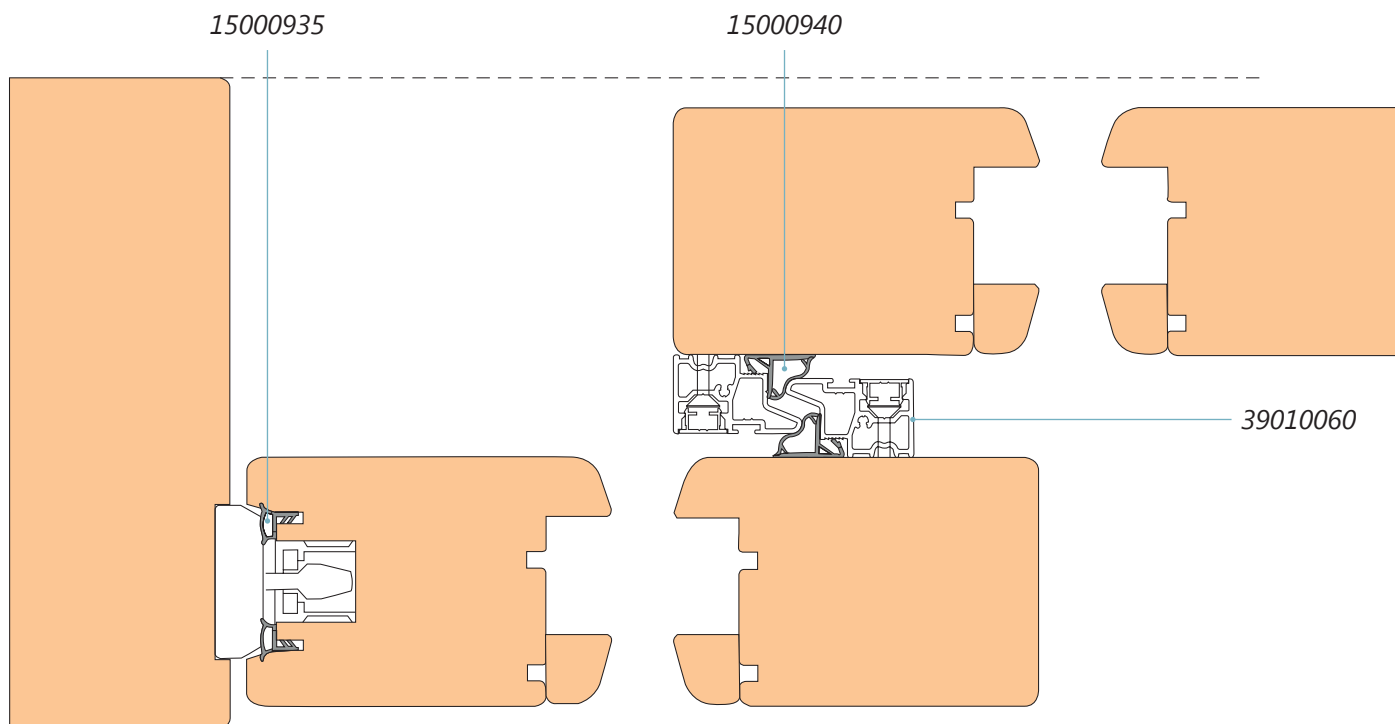

	Colore Colour	Codice Code	Quantità per imballo Packaging quantity
<p>TPE.2</p>	■	15000940.12	50 m
<p>TPE.2</p>	■	15000935.12	100 m

GUARNIZIONI ALZANTE SCORREVOLE

GASKETS-THRESHOLD SLIDING DOOR SYSTEM / JOINTS-SEUIL POUR PORTES COULISSANTES / JUNTAS DE GOMA-UMBRAL PARA PUERTAS CORREDERAS

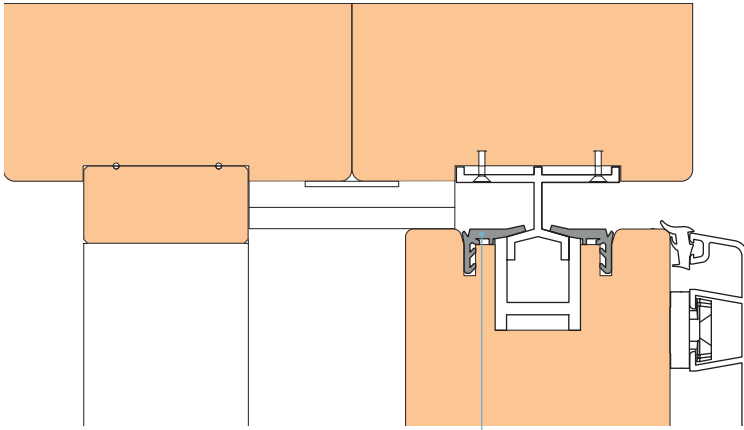

15000818

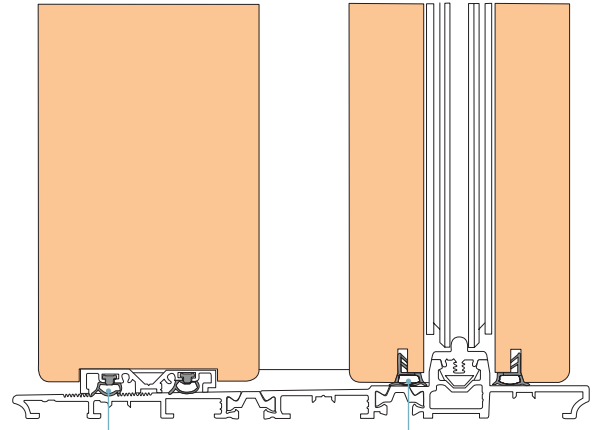

16000902

15000935

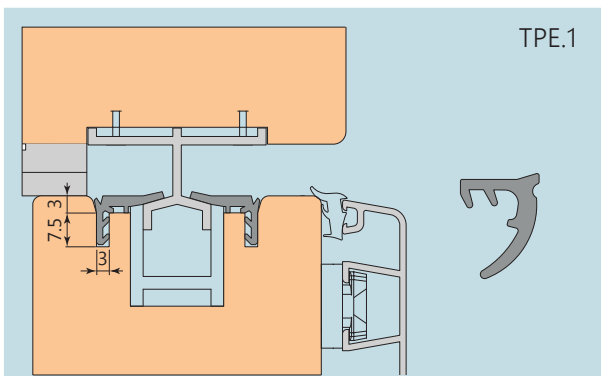

TPE.1

Colore
Colour



Codice
Code

15000818.12

Quantità per imballo
Packaging quantity

70 m

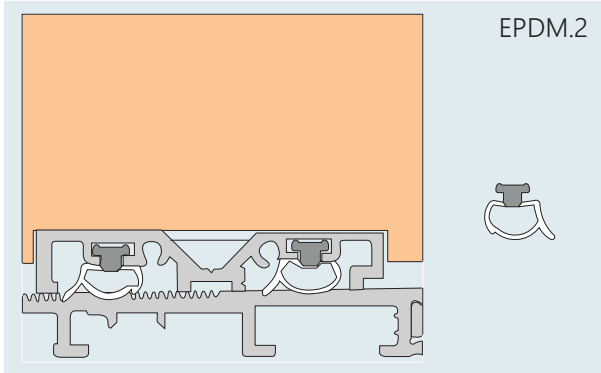

EPDM.2



16000902.12

60 m











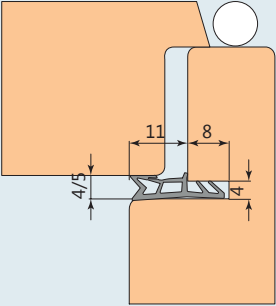



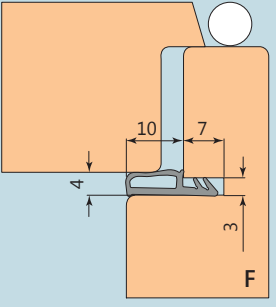



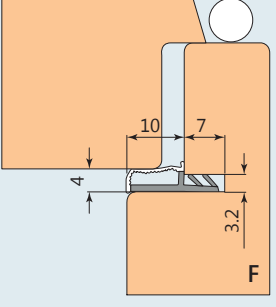

GUARNIZIONI PORTE

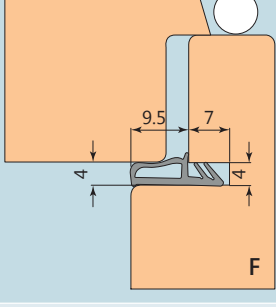



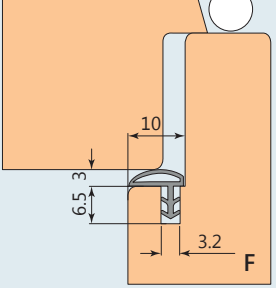





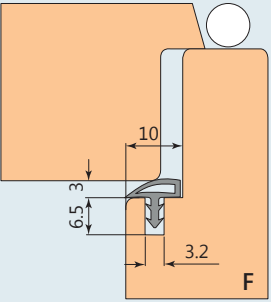



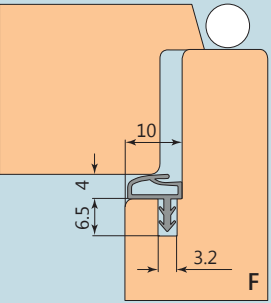



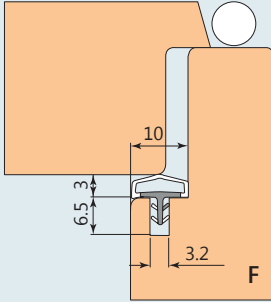

DOORS GASKETS / JOINTS DE PORTS / JUNTAS DE GOMA PUERTAS

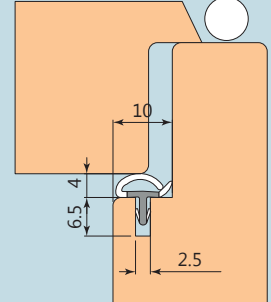

Guarnizioni per Telaio "F"

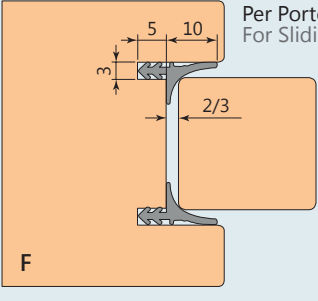
For Frame / Pour Dormant / Para Marco

	Colore Colour	Codice Code	Quantità per imballo Packaging quantity	Quantità per pallet Pallet quantity
 <p>PVC.1</p>		11000366.11	300 m	6.000 m
		11000366.12	300 m	6.000 m
		11000366.13	300 m	6.000 m
 <p>PVC.1</p>		11000374.11	300 m	6.000 m
		11000374.12	300 m	6.000 m
		11000374.13	300 m	6.000 m
 <p>PVC.2</p>		11000842.11	450 m	5.400 m
		11000842.12	450 m	5.400 m
		11000842.13	450 m	5.400 m
 <p>PVC.1</p>		11000510.11	150 m	7.500 m
		11000510.12	150 m	7.500 m
		11000510.13	150 m	7.500 m
 <p>PVC.1</p>		11000336.11	250 m	5.000 m
		11000336.12	250 m	5.000 m
		11000336.13	250 m	5.000 m

	Colore Colour	Codice Code	Quantità per imballo Packaging quantity	Quantità per pallet Pallet quantity
 <p>PVC.1</p>		11000360.11	250 m	5.000 m
		11000360.12	250 m	5.000 m
		11000360.13	250 m	5.000 m
 <p>PVC.1</p>		11000382.11	140 m	4.200 m
		11000382.12	140 m	4.200 m
		11000382.13	140 m	4.200 m
 <p>PVC.2</p>		11000835.11	275 m	5.500 m
		11000835.12	275 m	5.500 m
		11000835.13	275 m	5.500 m
 <p>PVC.2</p>		11000858.11	250 m	5.000 m
		11000858.12	250 m	5.000 m
		11000858.13	250 m	5.000 m
 <p>Per Porte scorrevoli For Sliding Doors</p> <p>TPE.1</p>		15000734.11	320 m	6.400 m
		15000734.12	320 m	6.400 m
		15000734.13	320 m	6.400 m

GUARNIZIONI PORTE

DOORS GASKETS / JOINTS DE PORTS / JUNTAS DE GOMA PUERTAS



PVC.1

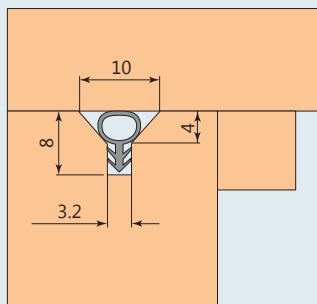

Colore
Colour

Codice
Code

Quantità per imballo
Packaging quantity

Quantità per pallet
Pallet quantity



11000140.11

200 m

6.000 m



11000140.12

200 m

6.000 m



11000140.13

200 m

6.000 m

Colore
Colour

Codice
Code

Quantità per imballo
Packaging quantity

Biblock

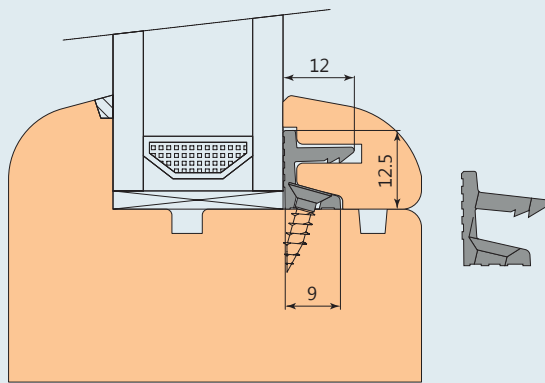
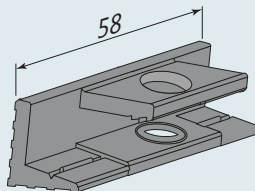

43905931.00

250 pz

Fascetta di legno reggivetro
Wood Clamp

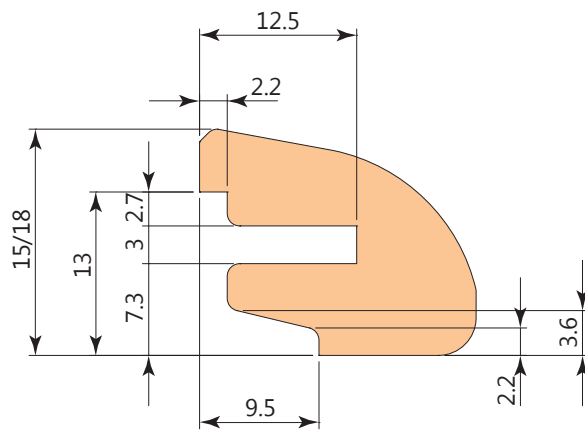

Montaggio

Mounting / Montage / Montaje

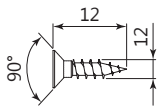

Graffa per applicazioni leggere

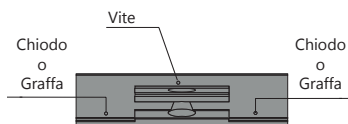
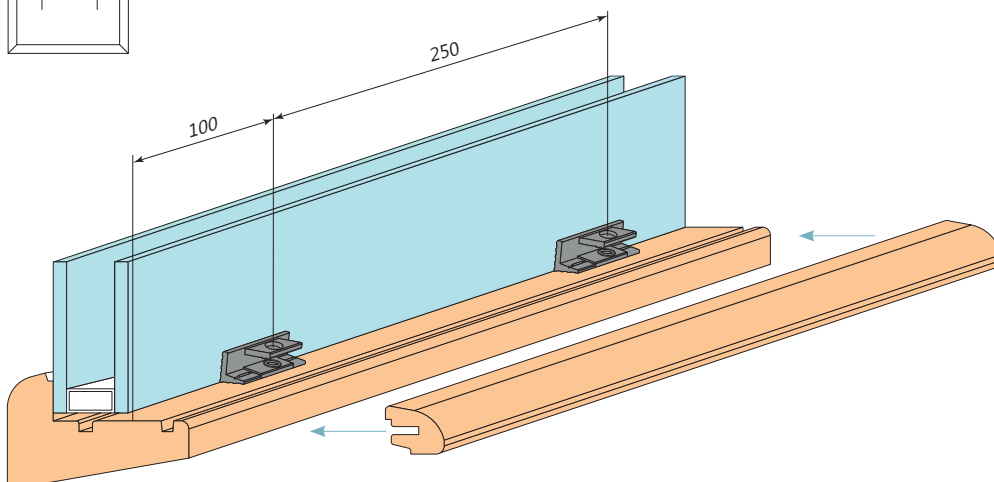
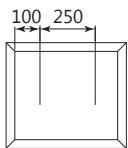

Vite

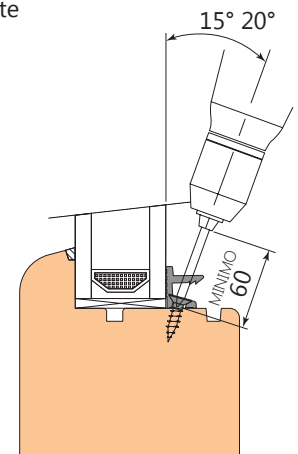

Graffa

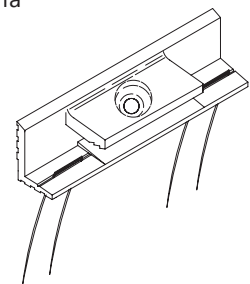

ACCESSORI

ACCESSORIES / ACCESSOIRES / ACCESOIRES

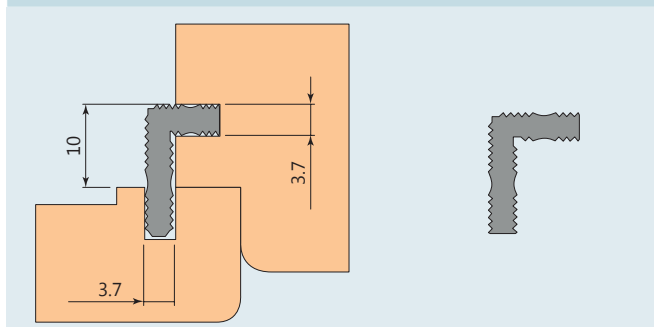
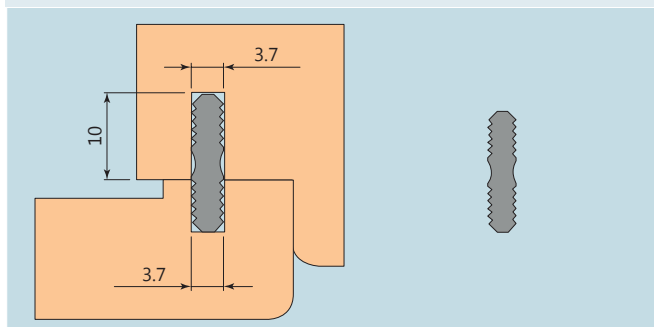
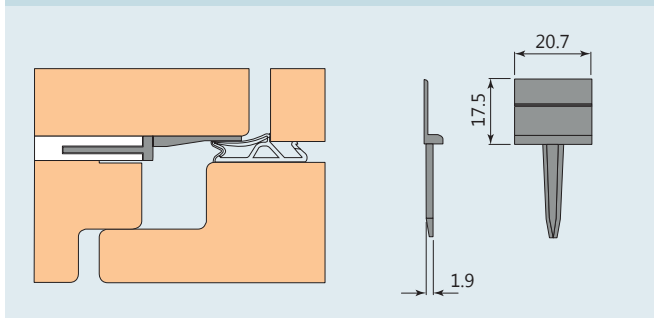
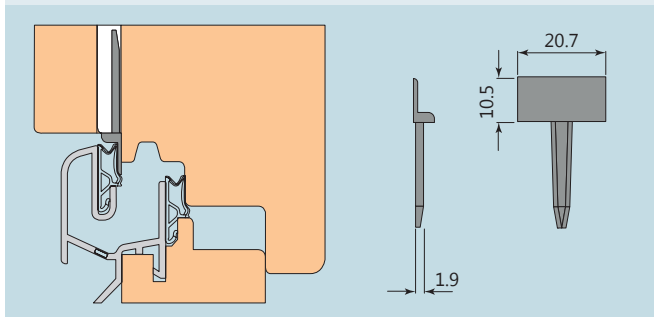
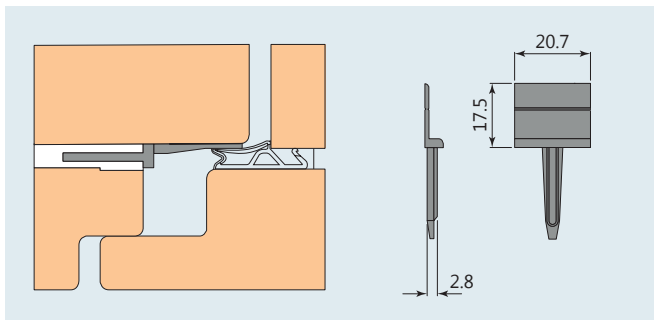

Colore Colour	Codice Code	Quantità per imballo Packaging quantity	
Pinnetta APPLICABILE SU APPLICABLE ON			
	41800468.11	200 pz	15000522
	41800468.12	200 pz	15000524
	41800468.13	200 pz	15000526
			15000528
			15000530
			15000854
Pinnetta APPLICABILE SU APPLICABLE ON			
	41801001.11	200 pz	15000800
	41801001.12	200 pz	15000802
	41801001.13	200 pz	15000816
			15000678
			15000732
			15000742
Pinnetta APPLICABILE SU APPLICABLE ON			
	41801002.11	200 pz	15000800
	41801002.12	200 pz	15000802
	41801002.13	200 pz	15000816
			15000678
			15000732
			15000742
Colore Colour	Codice Code	Quantità per imballo Packaging quantity	Quantità per pallet Pallet quantity
	10001057.12	220 m	2.200 m
Colore Colour	Codice Code	Quantità per imballo Packaging quantity	Quantità per pallet Pallet quantity
	10001151.12	220 m	2.200 m

Montaggio Pinnetta 41801001/41801002

Mounting Pinnetta / Montage Pinnetta / Pinnetta Montaje

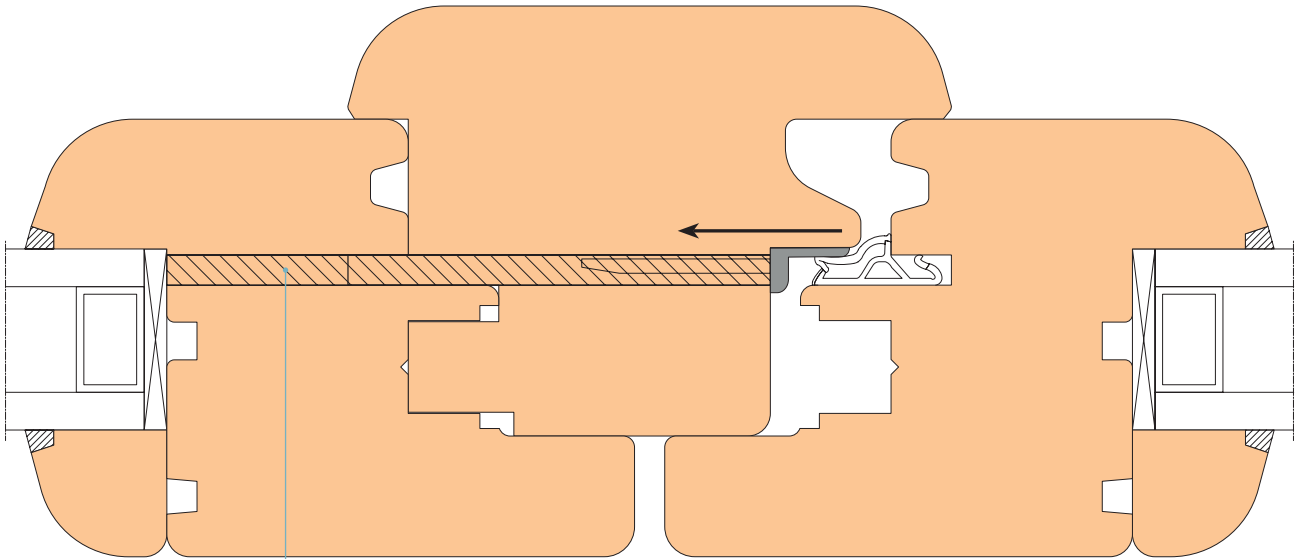

Guarnizione
Gasket / Joints / Juntas De Goma

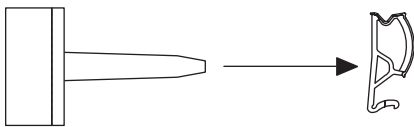

Esempio montaggio pinnetta

Example mounting pinnetta
Exemple de montage pinnetta
Pinnetta montaje Ejemplo

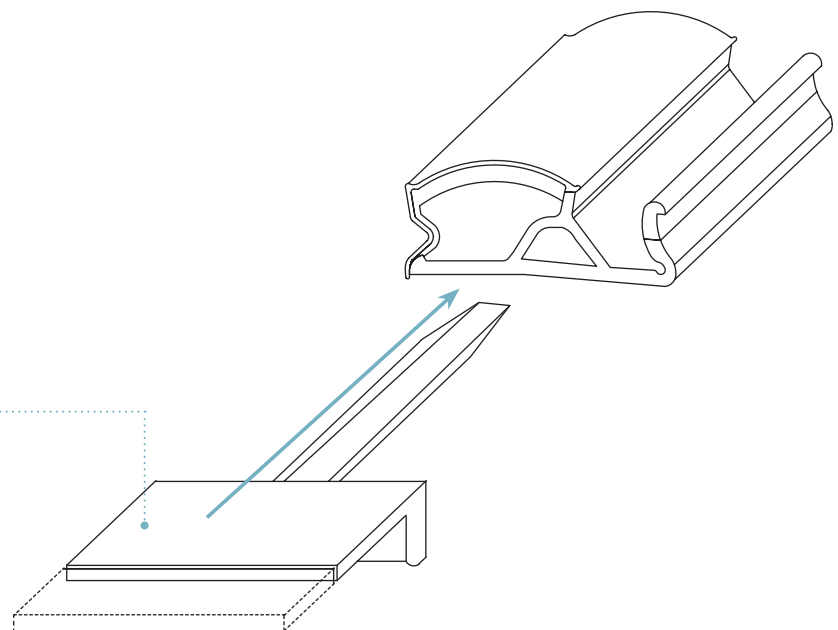

TAGLIO GUARNIZIONI

GASKET CUT / COUPES DE JOINTS / CORTES DE JUNTAS DE GOMA

OLIMPIA
wooden frames solutions

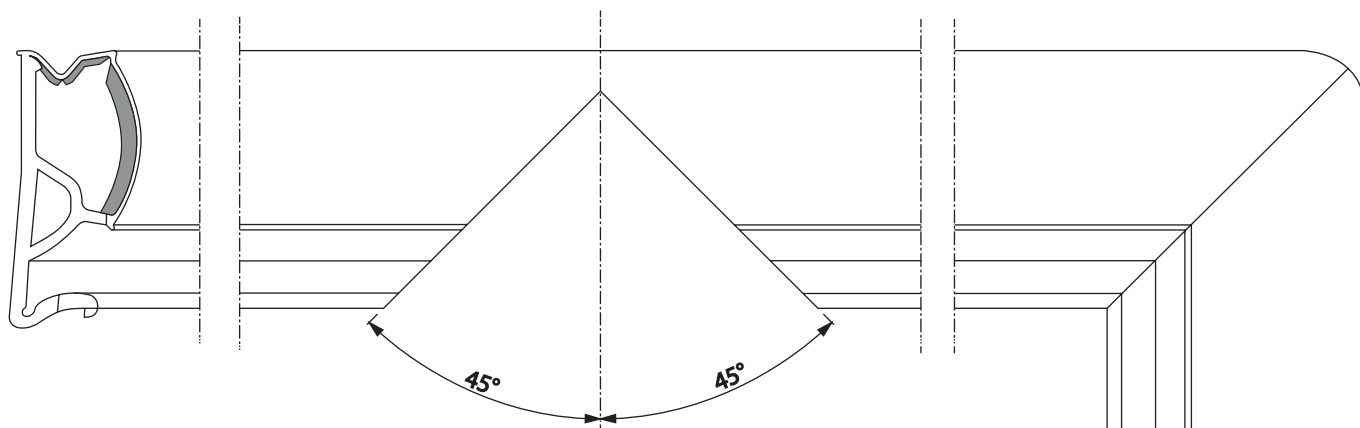

Forbice a 45° universale anta/telaio

Scissor 45° universal frame / windows
Ciseaux à 45° universelle pour ouvrant/dormant
Tijera a 45° universal hoja/marco

cod. 90000775

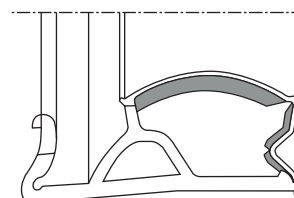

Inseritore per porte

Inserter for doors
Roulette de pose
Inseridor para puerta

cod. 90000503



Inseritore per finestre

Inserter for windows
Roulette de pose
Inseridor para ventana

cod. 90000504

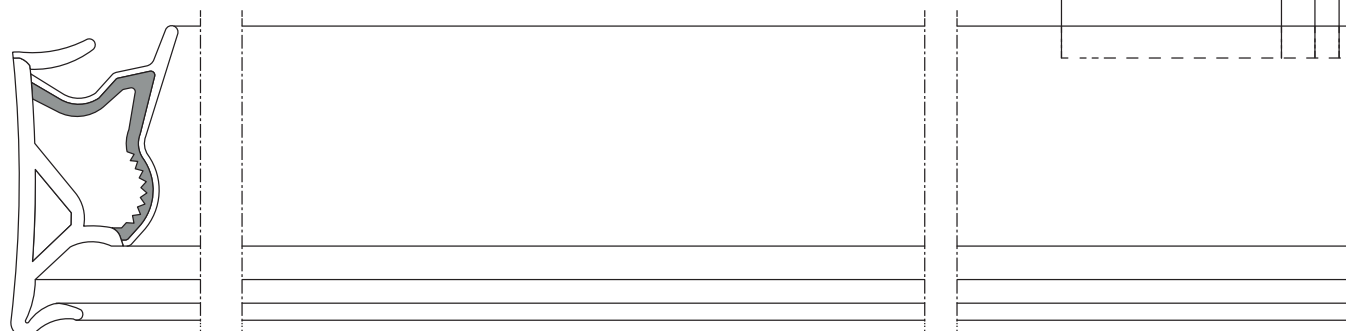
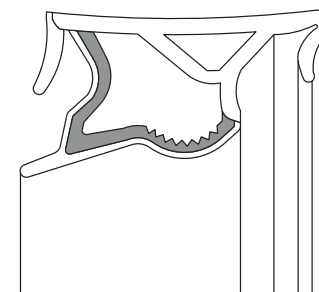

INDICE COLORE

COLOUR INDEX / INDEX DE LA COULEUR / ÍNDICE DE COLOR

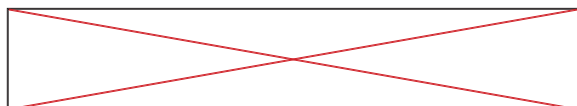

.00 Neutro

NEUTRAL / NEUTRE / NEUTRAL



.11 Marrone

BROWN / MARRON / CASTAÑO



.12 Nero

BLACK / NOIR / NEGRO



.13 Bianco

WHITE / BLANC / BLANCO



.26 Argento

SILVER / ARGENT / PLATA

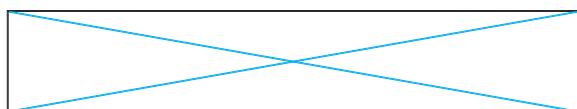

.50 Trasparente

TRASPARENT / TRASPARENT / TRASPARENTE

INDICE MATERIALE

MATERIAL INDEX / INDEX DE MATERIEL / ÍNDICE MATERIAL

TPE.1 = TPE (Termoplastico) monodensità *Monodensity / Monodensité / Monodensidad*

TPE.2 = TPE (Termoplastico) doppia densità *Double density / Double densités / Doble densidad*

TPE.3-S = TPE (Termoplastico) espanso a 3 densità *Triple density / trois densités / Tres densidad*

PVC.1 = PVC (Polivinilcloruro) monodensità *Monodensity / Monodensité / Monodensidad*

PVC.2 = PVC (Polivinilcloruro) doppia densità *Double density / Double densités / Doble densidad*

EPDM.2 = EPDM (Gomma Dutral Etilene - Propilene) doppia densità *Double density / Double densités / Doble densidad*

NOTE

notes / notes / notas

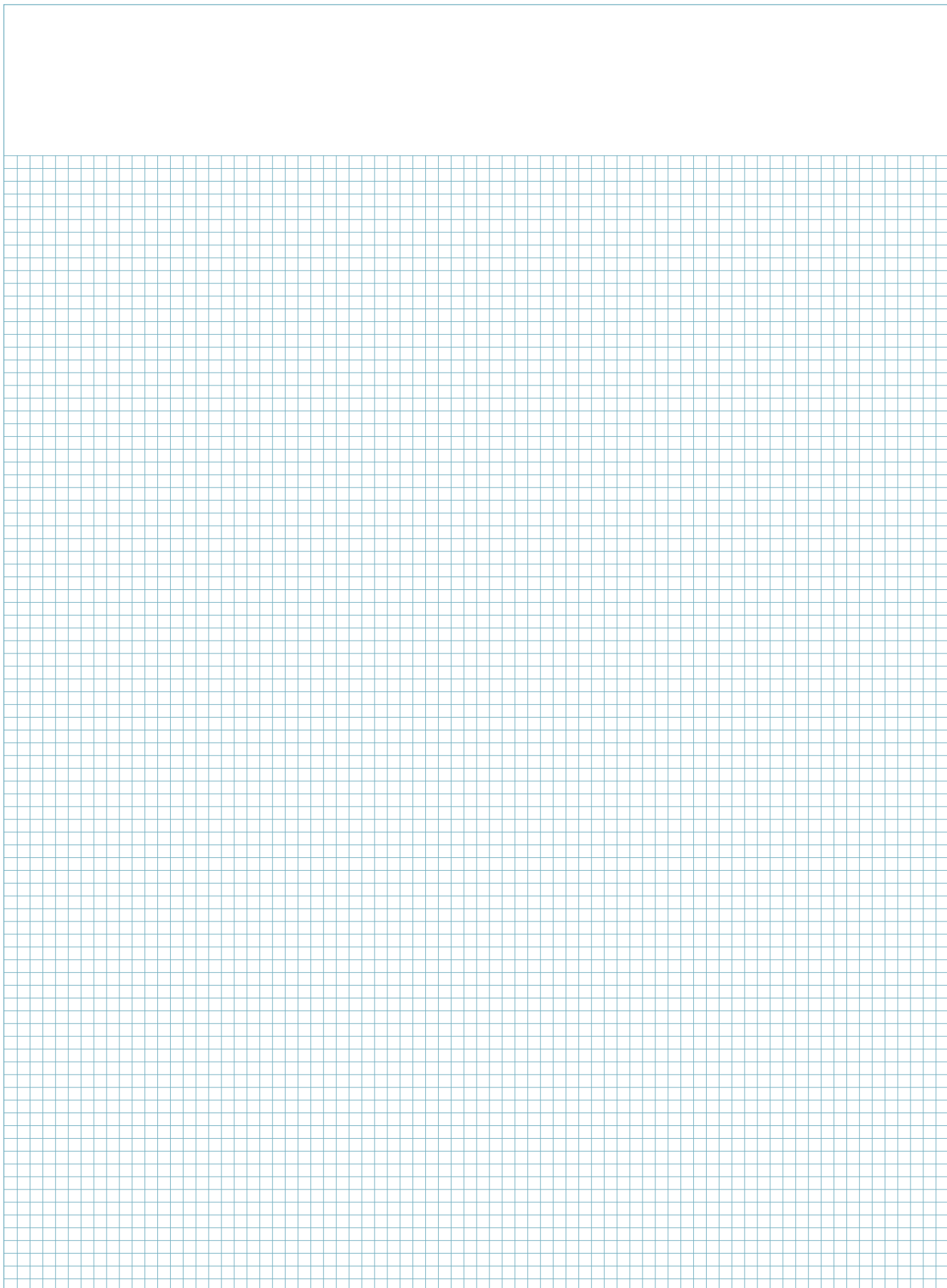

NOTE

notes / notes / notas

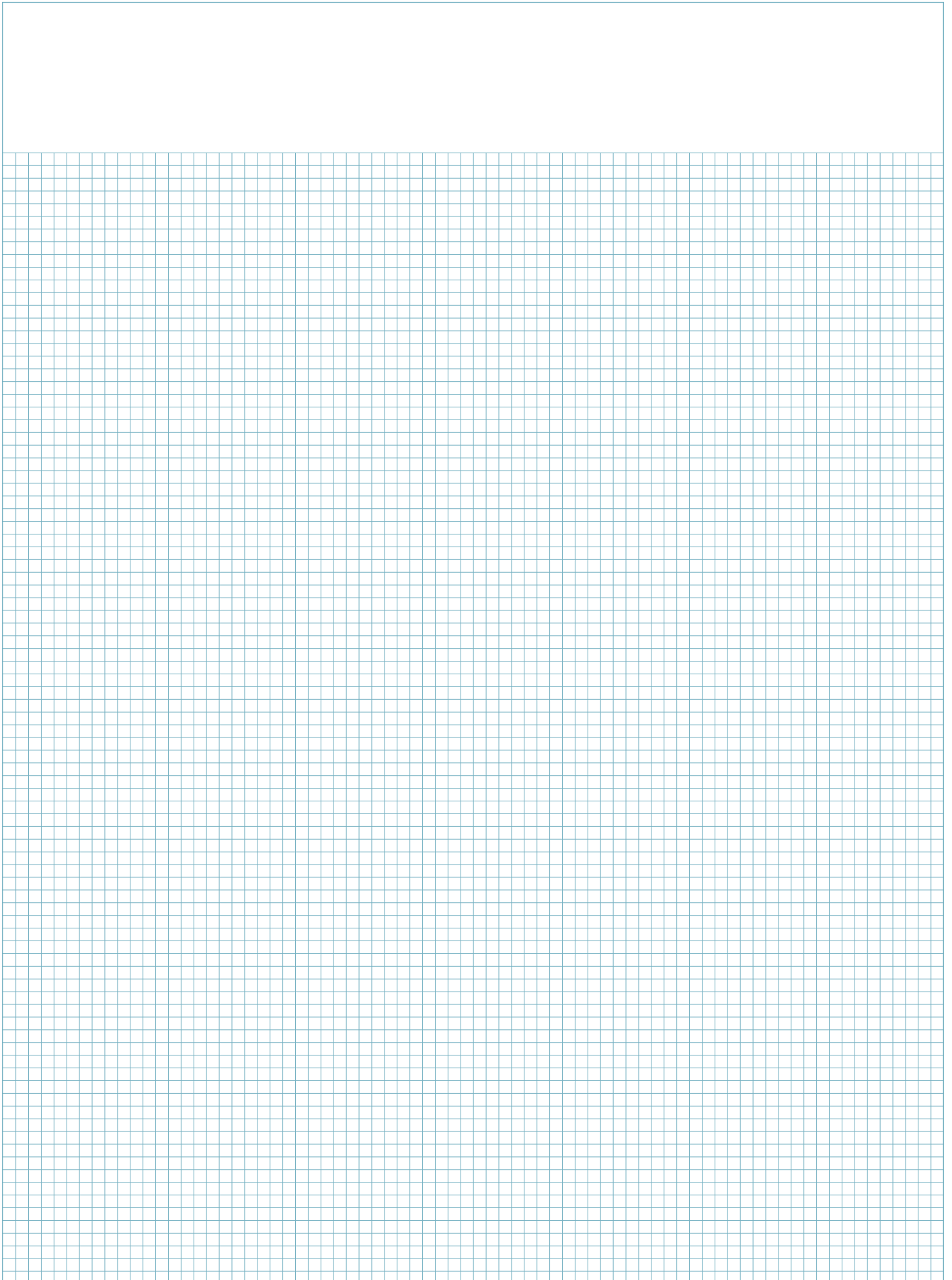



...OLTRE CIÒ CHE VEDI...

...BEYOND WHAT YOU SEE...

...AU-DELÀ DE CE QU'ON VOIS...

...MÁS ALLÁ DE LO QUE SE VE...



OLIMPIA Srl

Viale Serenissima, 32
30030 VIGONOVO (VE)
Tel. +39 049 870 5255
Fax +39 049 870 7726
info@olimpiasistemi.com

www.olimpiasistemi.com